

Plantronics Headset Compatibility

Please select the brand of phone you are trying to use with your Plantronics headset below:

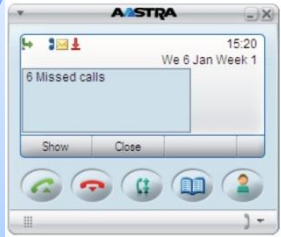

Softphone Compatibility



Aastra 2380ip
Softphone brings the telephone to the PC and is thus the perfect solution for employees who work from a home office or who are travelling



Aastra 400
offers an all-in-one Unified & Collaborative Communication solution which is seamlessly integrated into the system.



The Aastra BluStar™ Ecosystem
provides businesses with a comprehensive, end-to-end Unified Communication (UC) solution with a versatile choice of clients and devices.



MX-ONE solution can be deployed in a centralized or distributed fashion, for one system or a multiple networked system across hundreds of geographically dispersed locations

Plug-n-Play

Audio Only

Wireless headset



Voyager Legend UC



Savi 400 series



Savi 700 series

Corded headset



Blackwire 300 series



Blackwire 435



Blackwire 500 series



Blackwire 700 series



Calisto 240



Calisto 800 series

Speaker phone



Calisto 620

IP Phones Compatibility

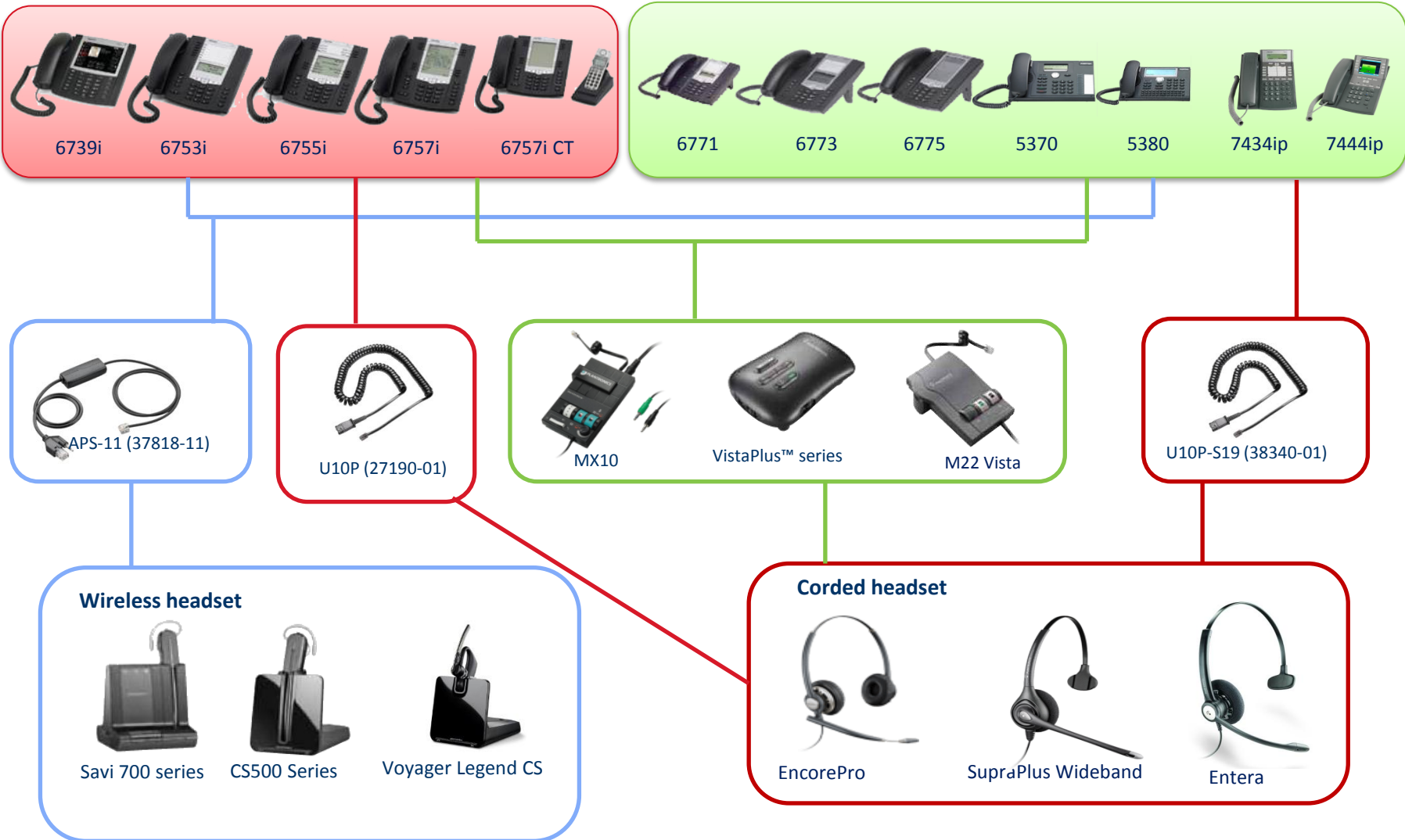

Setup Diagrams for Installation



Aastra

Supported Phones

Aastra 6771, 6113, 6775, 6773 IP, 6775 IP,
5370, 5380, 5370 IP, 5380 IP, 6753i
Aastra 6739i, 6755i, 6757i, 6757i CT*

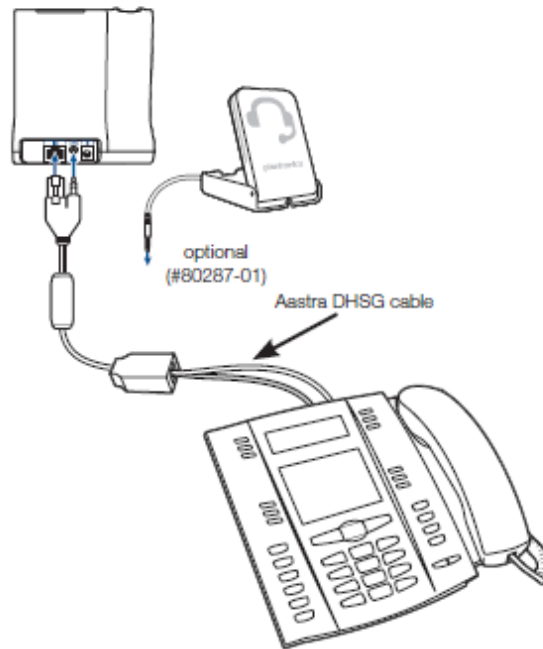

Only the Aastra DHSG cable should be connected directly to your phone. No 3rd party DHSG cables should be connected directly to the Aastra IP phone.

Plantronics EHS

APS 11

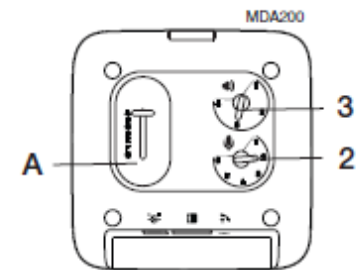
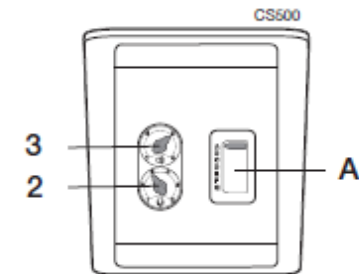
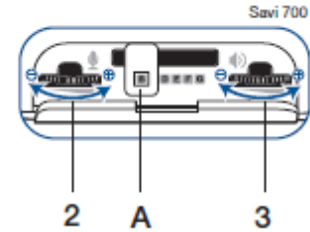

Softphone Compatibility

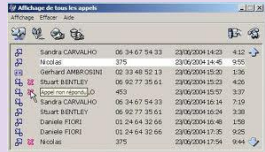

PIMPhony is a phone system that operates directly on a user's PC, transforming the PC into an IP terminal, and is particularly cost-effective for remote and mobile workers.



IP DESKPHONE is a Windows/MAC application installed on a user's computer, emulating a 4068, 4038 or 4028 IP Touch phone.

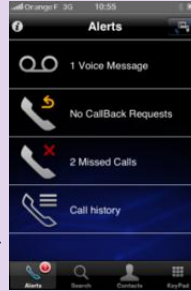

OmniTouch 8600 My Instant Communicator is multi-media, multi-session, multi-device unified communications client solution that can be integrated with existing business applications and accessed seamlessly from a computer, IP phone or PDA



4980 Softphone is a next-generation PC telephony application that manages communications and information by linking the desktop PC and the telephone. It seamlessly integrates with most popular workgroup applications.

Plug-n-Play

Plug-n-Play

Audio Only

Audio Only

Wireless headset



Voyager legend UC

Savi 400 series

Savi 700 series

Corded headset



Blackwire 300 series

Blackwire 435

Blackwire 500 series

Blackwire 700 series

Calisto 240 speaker phone



Calisto 620

Speaker phone



Calisto 800 series

IP Phones Compatibility



Octophon open 140 IP
Octophon open 141
Octophon open 150 IP
Octophon open 151
Octophon open 160 IP



OmniTouch 8082
MyIC



Touch 4029
Touch 4039
IP Touch 4028/EE
IP Touch 4038/EE
IP Touch 4068/EE



APA-23(38908-11)



MX10



VistaPlus™ series



M22 Vista



QD to 3.5mm (38324-01)

Wireless headset



Savi 700 series



CS500 Series



Voyager Legend CS

Corded headset



EncorePro



SupraPlus Wideband



Entera

Setup Diagrams for Installation

Alcatel

Supported Phones

IP Touch 4028, IP Touch 4038, IP Touch 4068

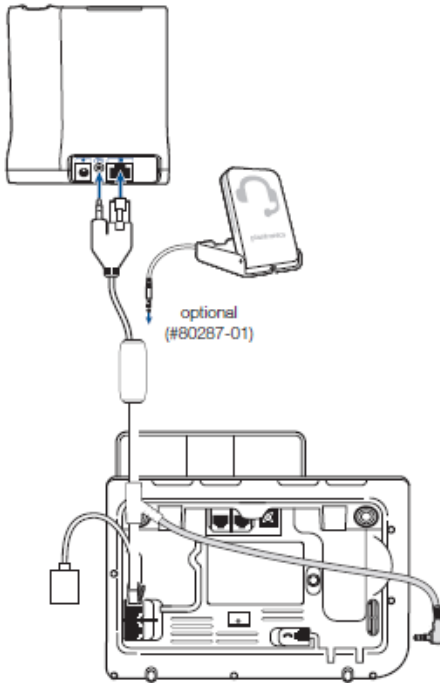

Plantronics EHS APA23

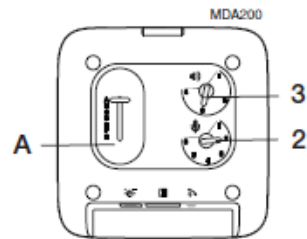
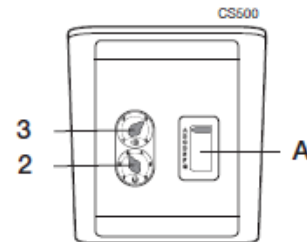
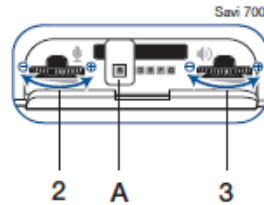

Alcatel

Supported Phones

Touch 4029, Touch 4039

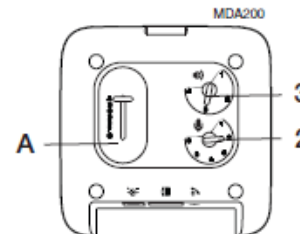
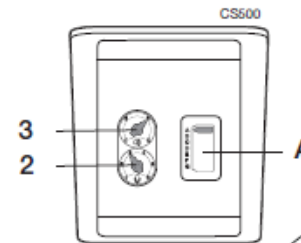
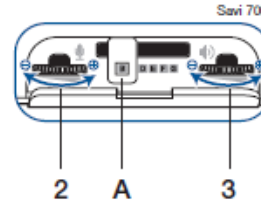

Plantronics EHS APA23

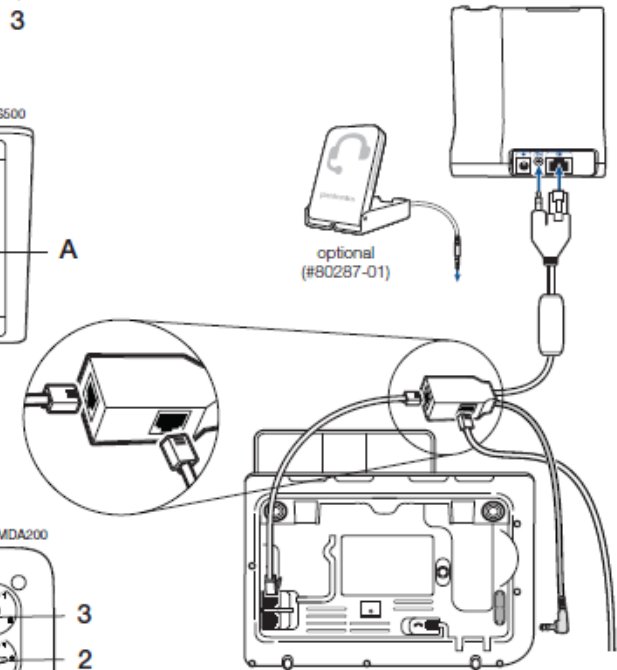

Softphone Compatibility

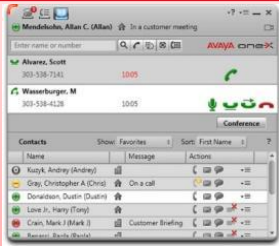

Avaya one-X® Communicator combines soft phone, intelligent presence, voice/video calling, visual voicemail and video conferencing, together with access to corporate directories and call logs, to help users better manage communication tasks.

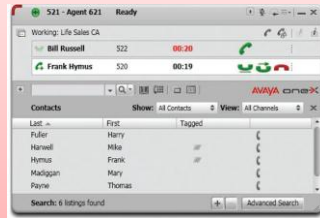

Avaya one-X® Agent is designed to meet the needs of Contact Center Agents by providing one-touch access to functions such as conference, transfer, supervisor assist, pre-recorded greetings, integrated presence and instant messaging.

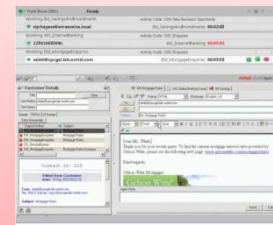

Avaya Aura Agent Desktop allows agents to simultaneously handle multiple contacts of various media types



IP Softphone is a full installer, as such it can be installed as an upgrade to any IP Softphone R6 series release

Spokes

Wireless headset



Savi 700 series



Savi 400 series



Voyager legend UC

Corded headset



Blackwire 300 series



Blackwire 500 series



Blackwire 435



Blackwire 700 series

Speaker phone



Calisto 240



Calisto 800 series



Calisto 620



Avaya One-X Attendant
PC based software application that integrates telephony with external caller data and workforce information. This application solution is easily expandable as business communication requirements for small, medium and large companies evolve over time

Plug-n-Play

Wireless headset



Savi 700 series



Savi 400 series



Voyager legend UC

Corded headset



Blackwire 300 series



Blackwire 435



Blackwire 500 series



Blackwire 700 series

Audio Only

Speaker phone



Calisto 800 series

IP Phones Compatibility



2410
4610 4620
4610SW 4620 SW 4621 SW
4622SW 4625SW 4630SW
5420 5610 5620 5621



MX10



VistaPlus™ series



M22 Vista



HIC cable (49323-44)



APV66 (38633-11)

Corded headset



SupraPlus Wideband



EncorePro



Entera

Wireless headset



Savi 700 series



CS500 Series



Voyager Legend CS

IP Phones Compatibility

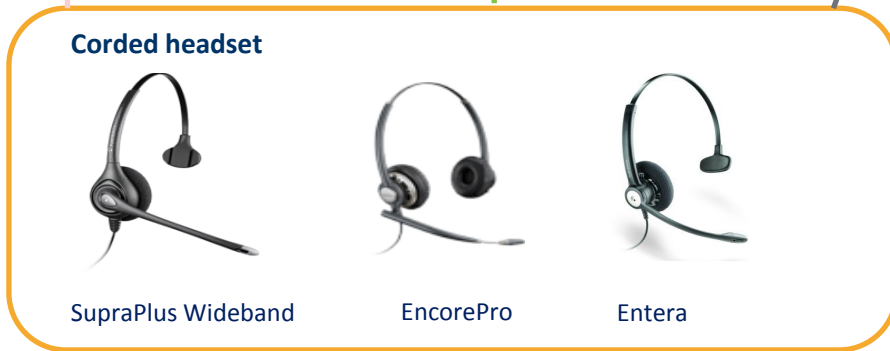
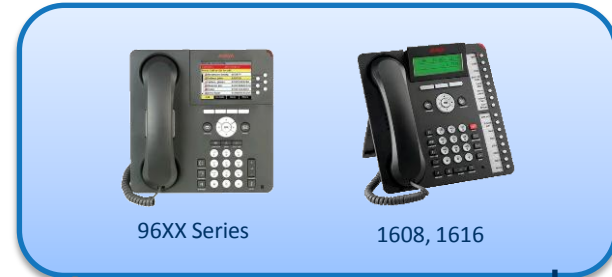

IP Phones Compatibility



Setup Diagrams for Installation



APV-66™ System Connections

Supported Phones

Avaya 2420*, 4610, 4610SW, 4620, 4620SW, 4621SW, 4622SW, 4625SW, 4630SW, 5420, 5610, 5620 and 5621 Telephones

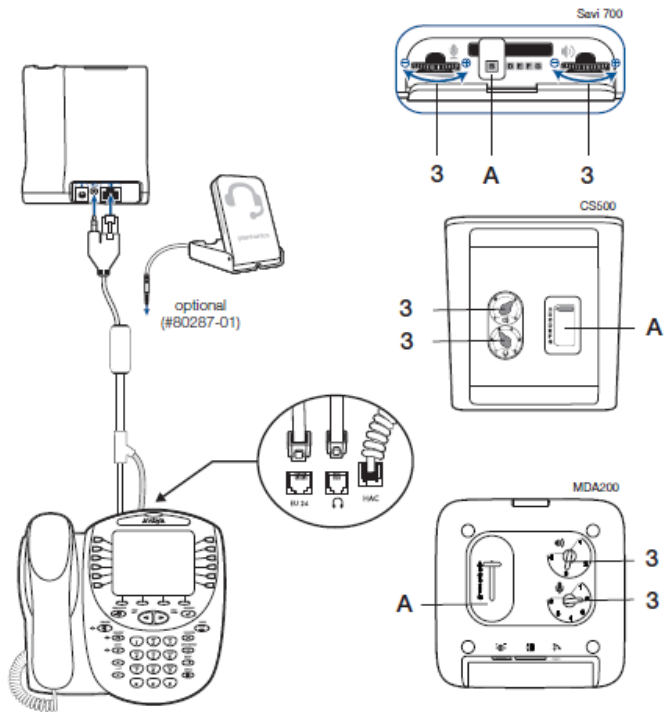

APV-63™ System Connections Setup 1

Supported Phones

Avaya 1408*, 1416*, 1608, 1616, 9404, 9406, 9504, 9508, 9608*, 9611*, 9620, 9621*, 9630, 9640, 9641G*, 9650, 9670 9620L Series Telephones

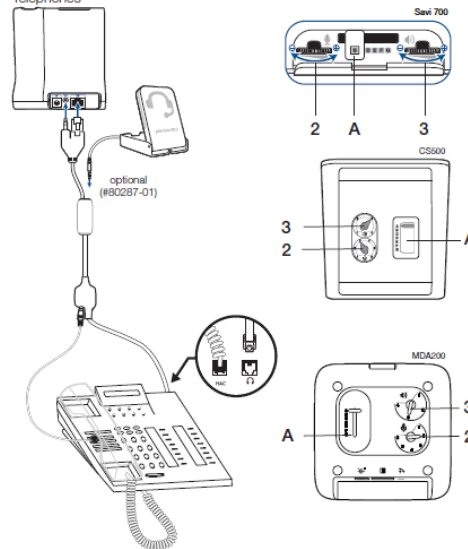

APV-63™ System Connections Setup 2

Supported Phones

Avaya 2410, 4630, 6416D+M, 6424D+M,

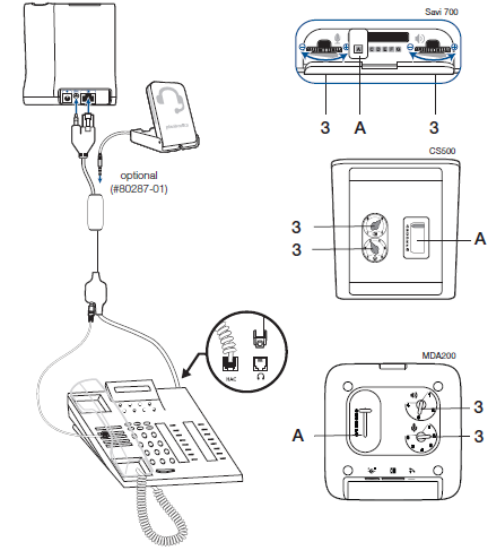

Setup Diagrams for Installation



Avaya-Nortel®

Supported Phones

1120E, 1140E, 1150E, 1165E

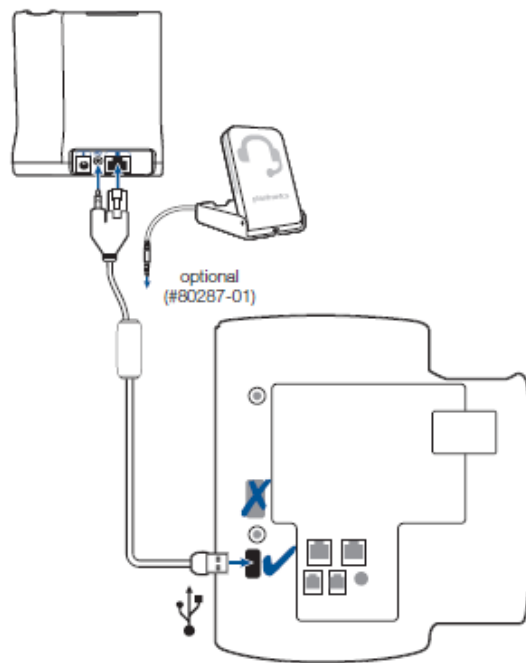

Plantronics EHS

APU71

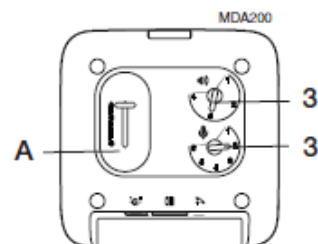
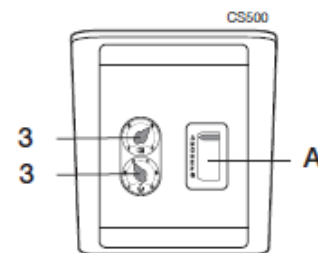
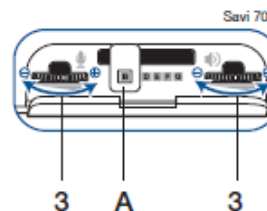

Softphone Compatibility



Cisco Jabber (9.2.1, 9.2.4)
Easily access voice, video, presence, instant messaging, voice messaging, desktop sharing, and conferencing capabilities

Plantronics Cisco Jabber plugin

| Wireless headset | | Corded headset and speaker phone | | | |
|--|---|--|---|--|--|
|  Savi 700 series |  Savi 400 series |  Blackwire 300 series |  Blackwire 435 series |  Blackwire 500 series |  Blackwire 700 series |
|  Voyager legend UC | |  Calisto 240 |  Calisto 800 series |  Calisto 620 | |

Softphone Compatibility

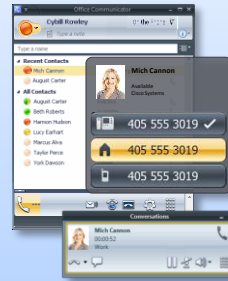

Cisco UC Integration for Microsoft® Lync™ (CUCI-LYNC V8.6(2), V9.2 (3)) integrates Cisco Call Manager with Lync, delivering phone control from Lync for voice calls PC to PC, and between PC and desk phone.

Version earlier than 9.2 is supported by Spokes. Version 9.2 and above are supported by Jabber plugin

Wireless headset



Savi 700 series



Savi 400 series



Voyager legend UC

Corded headset and speaker phone



Blackwire 300 series



Blackwire 435 series



Blackwire 500 series



Blackwire 700 series



Calisto 240



Calisto 800 series



Calisto 620

Softphone Compatibility



Cisco Unified Personal Communicator (CUPC) delivers a single multimedia interface on your PC for soft phone, presence, enterprise IM, visual VM, video and web conferencing.



Cisco IP Communicator (CIPC) is a Microsoft Windows-based soft-phone application that brings your work telephone to your personal computer.

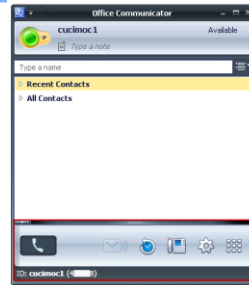

Cisco UC Integration for Microsoft Office Communicator (CUCI-MOC) integrates Cisco Call Manager with Microsoft Office Communicator, delivering phone control for voice calls PC to PC, and between PC and desk phone.

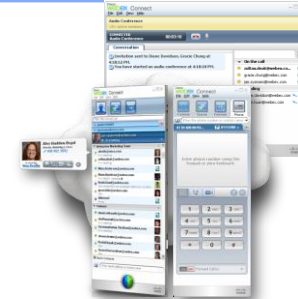

Cisco UC Integration for WebEx™ Connect (CUCI-Connect) enables collaboration using the best method to meet your immediate needs – phone, instant message, video conference or instant WebEx meeting.

Spokes

Wireless headset



Savi 700 series



Savi 400 series



Voyager legend UC

Corded headset and speaker phone



Blackwire 300 series



Blackwire 435 series



Blackwire 500 series



Blackwire 700 series



Calisto 240



Calisto 800 series



Calisto 620

Softphone Compatibility



Cisco IP Communicator (CIPC Native) v 8.6.3 and up endows the PC with the functions of IP phones, with voice and video calls from wherever you have access to the corporate network.

Plug-n-Play

Wireless headset



Savi 700 series



Savi 400 series



Voyager Legend UC

Corded headset and speaker phone



Blackwire 300 series



Blackwire 435 series



Blackwire 500 series



Blackwire 700 series



Calisto 240



Calisto 800 series



Calisto 620

Softphone Compatibility



8961/9951/9971 (firmware 9.2.3 and up) delivers high-quality, interactive multimedia communications and advanced features in an elegant ergonomic design that is user - and eco-friendly.

Plug-n-Play

Corded headset



Blackwire 300 series



Blackwire 435



Blackwire 500 series



Blackwire 700 series

Wireless headset



Savi 400 series



Voyager legend UC



APU71 (83018-11)

Wireless headset



Savi 700 series

IP Phones Compatibility



IP Phones Compatibility

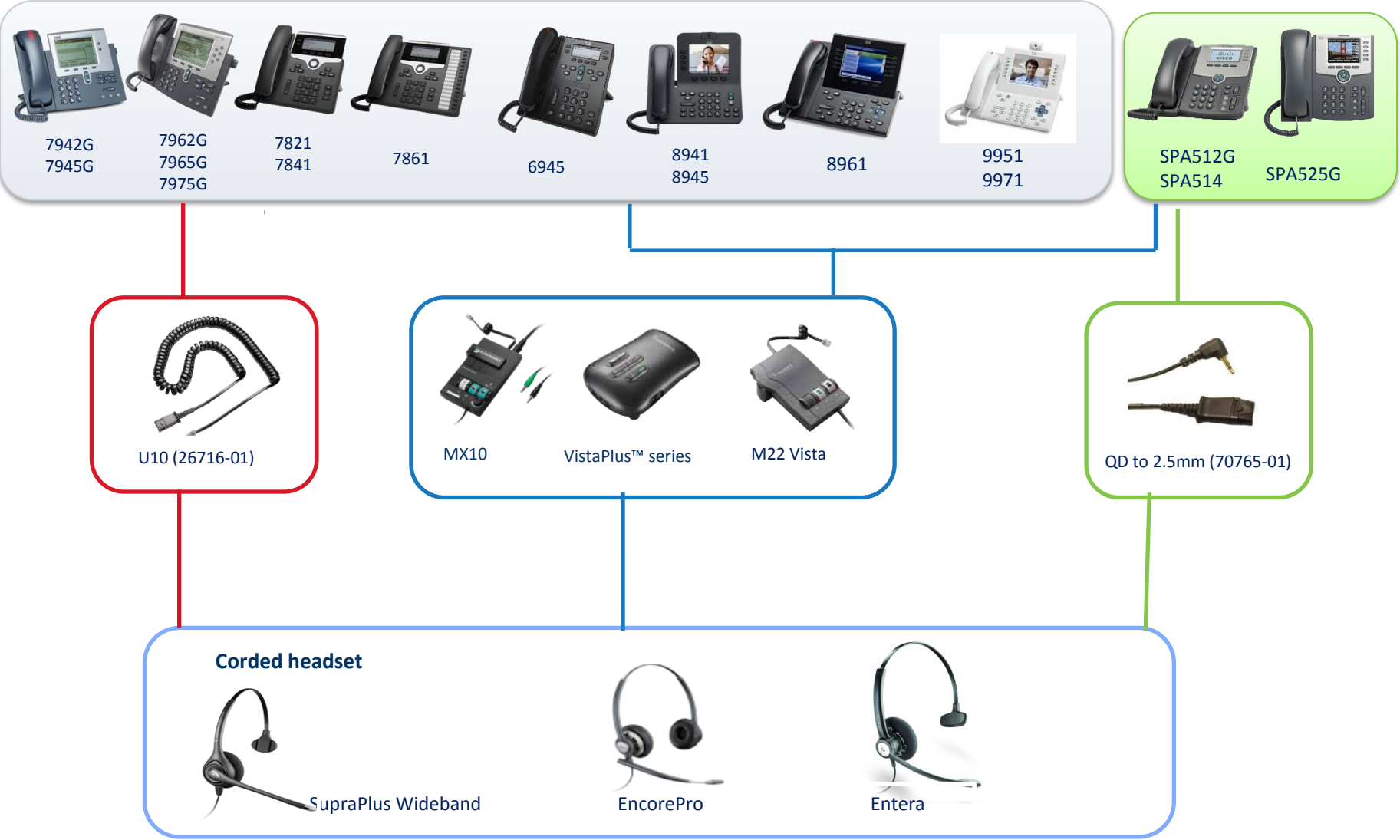

Setup Diagrams for Installation



APC42 System Connections Setup
For 7942G, 7945G, 7962G, 7965G, 7975G

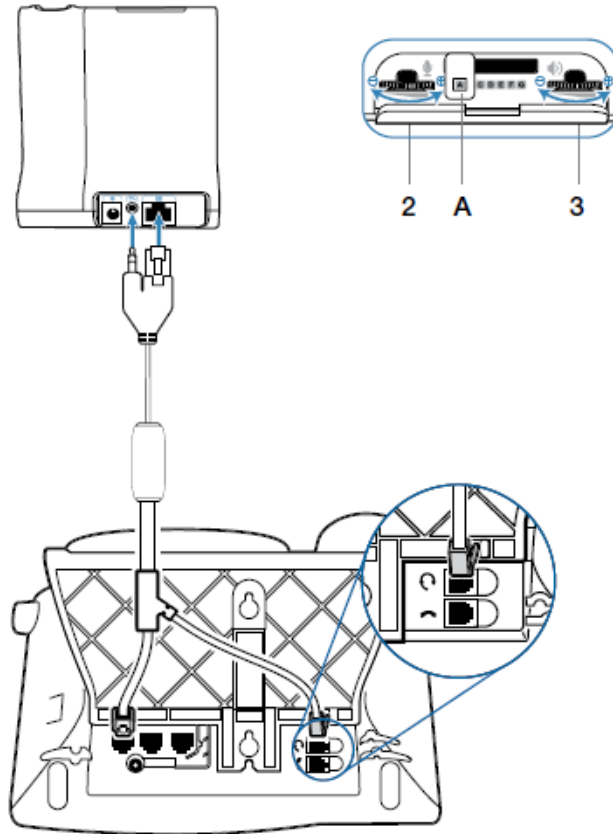

APU-71 System Connections Setup
For 8961, 9951, 9971

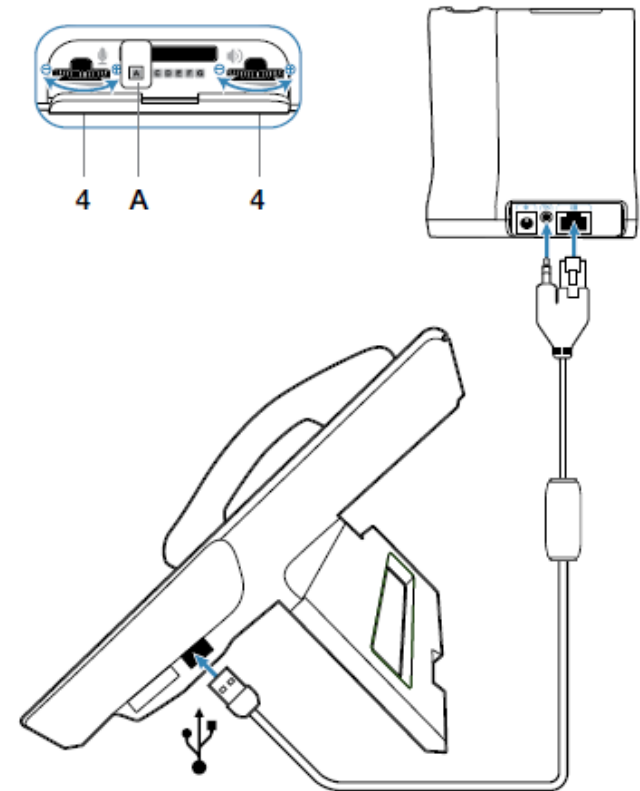

Softphone Compatibility



Bria is a carrier-grade next generation softphone application that enables you to manage your communications easily and efficiently – all from your computer desktop

Plug-n-Play

Audio Only

Wireless headset

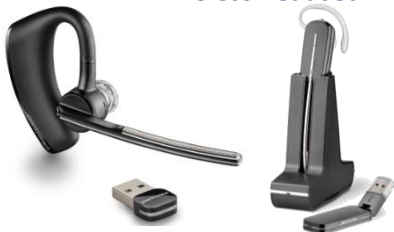

Voyager Legend UC Savi 400 series



Savi 700 series

Corded headset



Blackwire 435 Blackwire 500 series



Blackwire 700 series Blackwire 300 series

Speaker phone



Calisto 240



Calisto 800 series



Calisto620

Softphone Compatibility



X-Lite provides a completely redesigned interface that allows for a contact-centric user experience, with the convenience of a pop-out dialpad

Plug-n-Play

Audio Only

Wireless headset



Voyager legend UC Savi 400 series



Savi 700 series

Corded headset



Blackwire 435 Blackwire 500 series



Blackwire 700 series

Speaker phone



Calisto 240



Calisto 800 series



Blackwire 300 series



Calisto620

IP Phone Compatibility



IP Phone Compatibility



GXP2124



GXP 2140



GXP 2160

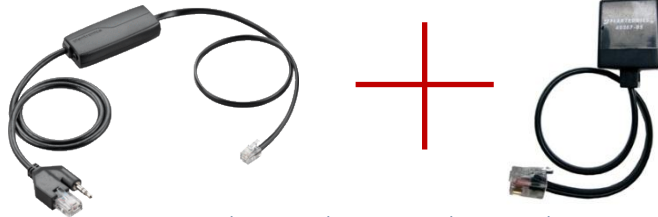

APD-80 (87327-01) +40287-05 (85638-01)



U10P-S (38099-01)

Wireless headset



Savi 700 series



CS500 Series



Voyager Legend CS

Corded headset



EncorePro



SupraPlus Wideband



Entera

Softphone Compatibility

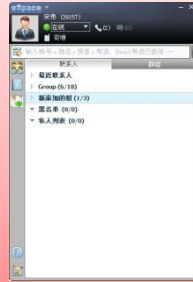

eSpace integrates multiple communication modes and provides self services, calls, short messages, instant messages, and instant conferences.

Plug-n-Play

Audio Only

Wireless headset



Voyager Legend UC



Savi 400 series



Savi 700 series

Corded headset



Blackwire 435



Blackwire 300 series



Blackwire 700 series



Blackwire 500 series

Speaker phone



Calisto 240



Calisto 620

Speaker phone



Calisto 800 series

IP Phones Compatibility



7810

7820

7830

7850

7870



7910



7950



U10P-S (38099-01)



HL10



U10P (27190-01)



APD-80 (87327-01)

Wired headset



Entera

SupraPlus
HW251N

Wireless headset



Savi 700 Series Voyager Legend CS



Voyager Legend UC



Blackwire 300 series



Blackwire 500 series



Blackwire 700 series

Softphone Compatibility

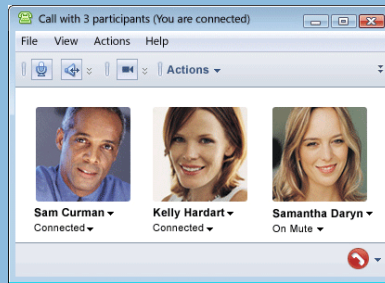
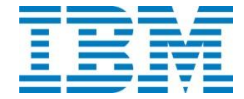

IBM Sametime provides users a unified user experience across a broad range of integrated real-time communications services – voice, data, and video, from IM to online meetings, VoIP and telephony integration.

Sametime Plugin v 2.0 and higher

Wireless headset



Voyager Legend UC



Savi 400 series



Savi 700 series

Corded headset



Blackwire 300 series



Blackwire 435



Blackwire 500 series



Blackwire 700 series

Speaker phone & Corded headset



Calisto 240



Calisto 800 series



Calisto 620

Softphone Compatibility

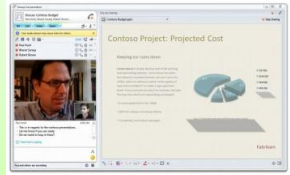

Lync™ 2010 makes joining and managing conferences, searching the Global Address List, and viewing presence information easy.

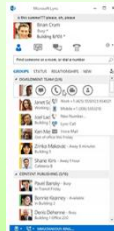

Lync™ 2013 Lync has always made it easy for people to communicate wherever they are, but we're making it even better with new and improved features:

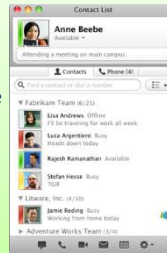

Lync for Mac 2011 is the new rich client for Lync users on the Mac platform and offers integrated functionality for instant messaging, presence, conferencing and voice.

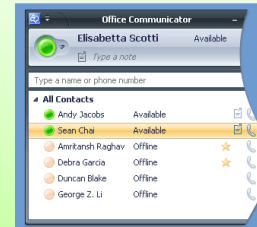

Communicator 2007 provides an easy-to-use interface that enables you to communicate in real time through instant messaging. It also provides audio and video conferencing.

Plug-n-Play

Wireless headset



Savi 700 series



Savi 400 series



Voyager legend UC

Corded headset



Blackwire 300 series



Blackwire 500 series



Blackwire 435



Blackwire 700 series

Speaker phone



Calisto 240



Calisto 800 series



Calisto 620



UNIVERGE Soft Client SP350 delivers full-featured telephony to the desktop with the full complement of call handling and convergence capabilities including video conferencing and real time collaboration.

Spokes

Wireless headset



Savi 700 series



Savi 400 series



Voyager legend UC

Corded headset



Blackwire 300 series



Blackwire 435



Blackwire 500 series



Blackwire 700 series

Speaker phone



Calisto 240



Calisto 800 series



Calisto 620

IP Phone Compatibility



IP Phone Compatibility

Panasonic



KX-UT133



KX-UT136



KX-UT248



KX-UT670



PSB, 3.5mm to 3.5mm (84757-01)



QD to 2.5mm (70765-01)

Wireless headset



Savi 700 series



CS500 Series



Voyager Legend CS

Corded headset



SupraPlus Wideband



EncorePro



Entera

Softphone Compatibility



VVX500 A performance business media phone that delivers best-in-class desktop productivity and unified communications for busy professionals



VVX® 600 A premium business media phone delivering best-in-class desktop productivity for busy corporate executives and managers

Plug-n-Play

Wireless headset



Voyager legend UC



Savi 400 series

Corded headset



Blackwire 300 series



Blackwire 435



Blackwire 500 series



Blackwire 700 series



APP-51 (38439-11)

Wireless headset



Savi 700 series

IP Phone Compatibility



IP320/321
IP330/331



IP335



IP430 /IP450



IP550/ IP560



IP650 / IP670



VVX 1500



QD to 2.5mm (70765-01)



U10P (27190-01)



MX10



VistaPlus™ series



M22 Vista



APP-51 (38439-11)

Corded headset



SupraPlus Wideband



EncorePro



Entera

Wireless headset



Savi 700 series



CS500 Series



Voyager Legend CS

Setup Diagrams for Installation

Supported Phones

SoundPoint® IP 320*, SoundPoint® IP 330*,
SoundPoint® IP 430, SoundPoint® IP 450,
SoundPoint® IP 550, SoundPoint® IP 560,
SoundPoint® IP 650, SoundPoint® IP 670

Plantronics EHS

APP-51

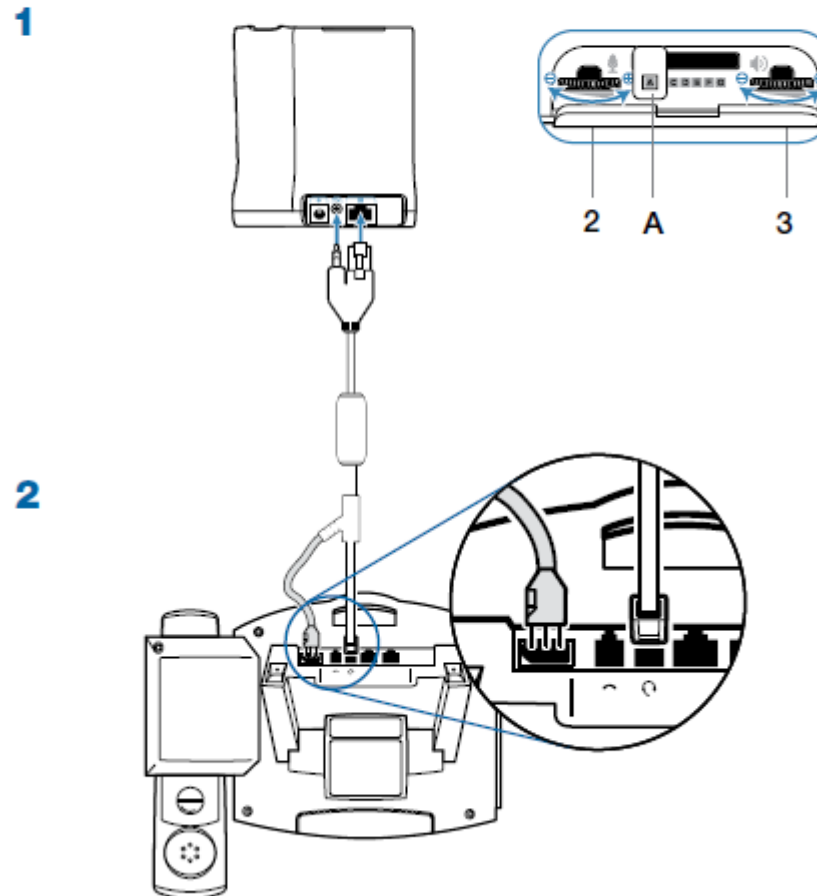

Softphone Compatibility

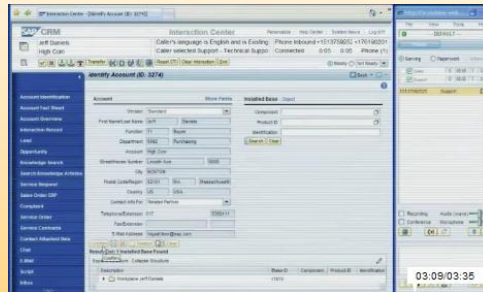

SAP Business Communication Management includes inbound and outbound Contact Center, native integration with SAP CRM, reporting and monitoring set yourself apart with superior customer

Plug-n-Play

Audio Only

Wireless headset



Voyager Legend UC



Savi 400 series



Savi 700 series

Corded headset



Blackwire 300 series



Blackwire 435



Blackwire 500 series



Blackwire 700 series

Speaker phone



Calisto 240



Calisto 800 series













Calisto 620



ShoreTel Communicator presents end-users a single interface to manage business communications using their ShoreTel desk phone, computer, mobile phone, or home telephone. The application integrates with Microsoft Outlook, and provides visual voicemail, call notes, and routing information.

Spokes

| Wireless headset | | Corded headset | | Speaker phone | |
|--|--|---|---|---|---|
|  Voyager Legend UC |  Savi 400 series |  Blackwire 300 series |  Blackwire 435 |  Calisto 240 |  Calisto 800 series |
|  Savi 700 series | |  Blackwire 500 series |  Blackwire 700 series | |  Calisto 620 |

IP Phones Compatibility



Setup Diagrams for Installation

ShoreTel models: IP 212K, 230, 265, 560, 560G, 560G, 655

Setup

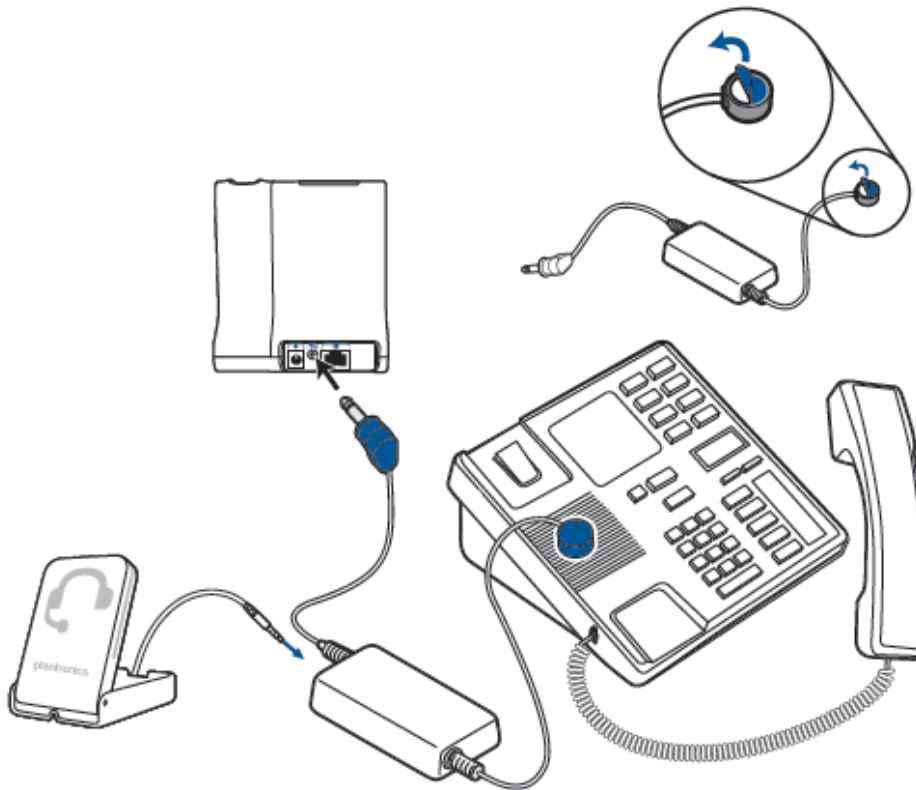

Configuration

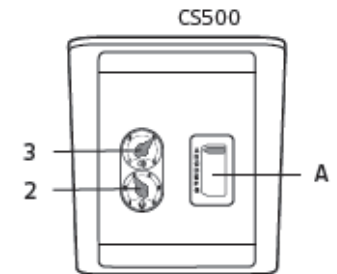
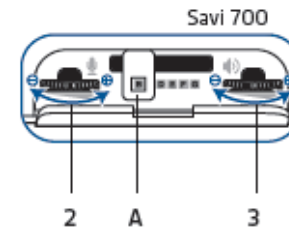



OpenScape UC Personal Edition is an entry-level unified communications and collaboration soft client designed for individuals who are mainly office-based, but sometimes work from home or are occasionally mobile.

Plug-n-Play

Audio Only

Wireless headset



Savi 700 series



Savi 400 series



Voyager Legend UC

Corded headset



Blackwire 300 series



Blackwire 435



Calisto 240



Blackwire 500 series



Blackwire 700 series

Speaker phone



Calisto 800 series



Calisto 620

IP Phones Compatibility

SIEMENS



APS11 System Connections Setup

For OpenStage 40, OpenStage 60,
OpenStage80

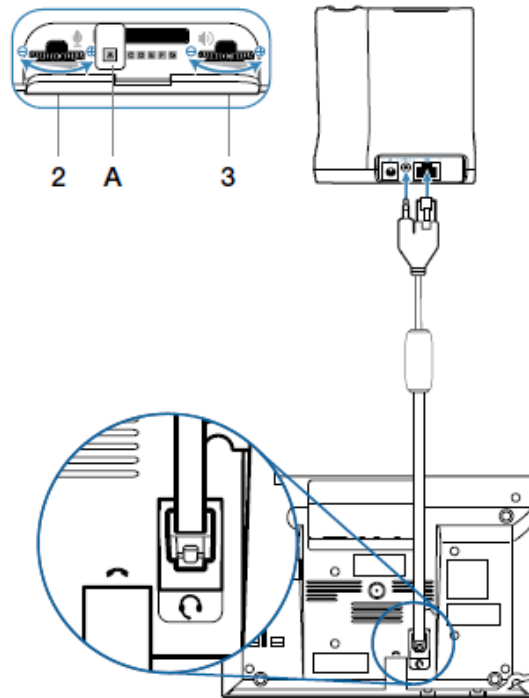

APS11 System Connections Setup

For Optipoint 410, Optipoint 420, Optipoint 500,
Optipoint 600

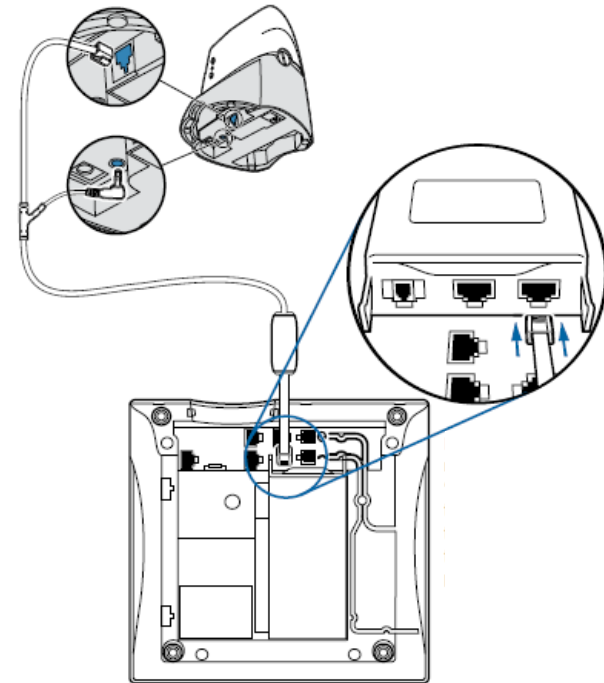

Softphone Compatibility



Skype for windows and Mac is a free premium voice-over-IP service and instant messaging client.

Spokes

Wireless headset



Voyager legend UC



Savi 400 series



Savi 700 series

Corded headset



Blackwire 300 series



Blackwire 500 series



Blackwire 435



Blackwire 700 series

Speaker phone



Calisto 240



Calisto 800 series



Calisto 620

IP Phone Compatibility

TOSHIBA



Setup Diagrams for Installation

TOSHIBA

Toshiba models: DP 5130-SDL, DP 5X22-SD, DP-5X32, IPT 2008-SDL, IPT 2010-SDL, IPT 2020-SD

Setup

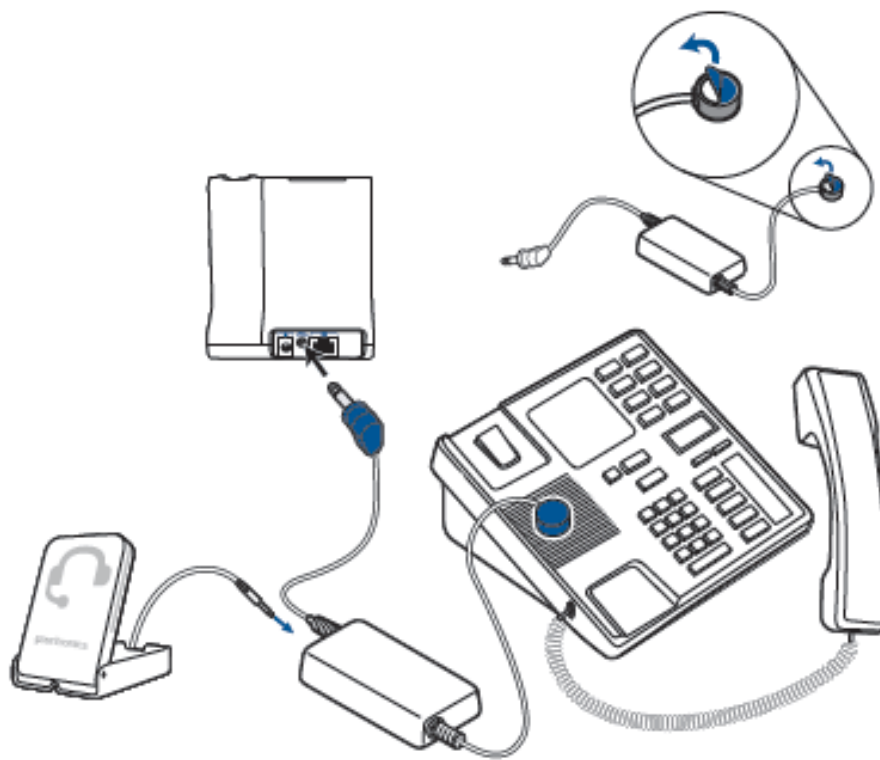

Configuration

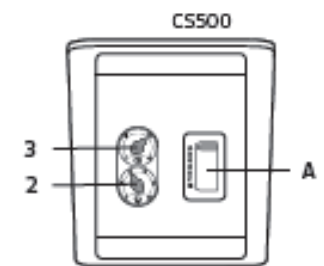
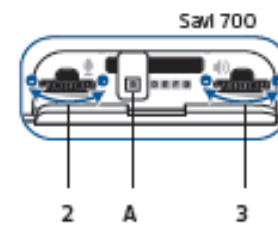

IP Phone Compatibility



SIP- T26P

SIP- T28P

SIP- T38G



SIP-T20P

SIP-T22P

SIP-T32G



EHS36



U10P-S (38099-01)



VP530

Wireless headset



Savi 700 series



CS500 Series



Voyager Legend CS

Corded headset



SupraPlus Wideband



Entera



Practica® SP11



M175®

Wireless Headsets *

* Product availability may vary by country



Savi 700 Series

Multiple devices. Singular Control.

Target Customer: Executives requiring multi-device communication and on-campus mobility

- The multi-device wireless headset system that manages all of your calls
- Most wearing style choice of any wireless headset system
- Wireless freedom up to 100 meters from your desk
- One-touch call answer/end, vol +/-, mute and flash
- Adaptive power system for longer talk and standby times
- Don't just manage calls, bring them together with advanced audio mixing
- Conference in up to three additional headsets
- Voice-dedicated DECT technology eliminates Wi-Fi interference

*Hot swappable battery for Savi 740 only, additional battery sold separately



Savi 400 Series

Wireless freedom that won't weigh you down

Target Customer: Laptop-centric office and remote workers requiring portable PC communications

- USB Wireless Headset System to manage PC voice communications and multi-media
- Lightest DECT™ wireless headset on the market
- Choice of three comfortable wearing styles
- Multitask, hands-free up to 90M
- Hot swappable battery for unlimited talk time*
- One-touch call answer/end, vol+/-, mute and flash with supported softphones
- Advanced wideband audio using CAT-iq technology
- Includes carrying pouch for use on-the-go
- UC Standard and Optimized for Microsoft OCS/LYNC versions available

*Additional battery sold separately



CS500 Series

Another CS family headed for the bestseller list

Target Customer: Office and desk-centric workers across the enterprise looking for a simple-to-set-up, simple-to-use wireless offering for managing desk phone calls

- Updated design
- New convertible headset (CS540)– Lightest DECT™ headset in the market (21 grams)– Up to 7 hours talk time on single charge– Elegant magnetic docking and instant mute
- Wideband audio for clear communications
- Conference in up to three additional headsets
- New DECT technology: Up to 100m range
- Adaptive power for optimal range and battery life

Wireless Headsets *

* Product availability may vary by country



Voyager Legend UC

The only UC headset you need for everywhere you work.

Target Customer: Mobile professionals who use PC audio, mobile phone, or tablet communications; featuring Smart Sensor technology, now with voice command menu (mobile phone only)

- Manage PC and mobile device calls from a single headset
- Smart Sensor™ technology for a seamless and intuitive user experience
- Bluetooth® mini USB adapter for always-ready PC connectivity
- Includes portable case and desktop stand for anywhere charging
- Precision tuned triple-mic with enhanced DSP for superior noise cancellation
- Three layers of wind noise protection
- PC Wideband delivers heightened speech clarity



Voyager Legend™ CS

The headset system that moves with you throughout your day. Enjoy intuitive call management and outstanding audio from your mobile phone on the road to your desk phone in the office, and everywhere in between.

- Manage desk phone and mobile device calls from a single headset
- Smart Sensor™ technology for a seamless and intuitive user experience
- Roam up to 10 meters from desktop charging base or mobile device
- Use your voice to answer incoming calls and for a host of other commands¹
- Enhanced voice alerts tell you connection status, talk time remaining and more
- Announces incoming caller's name for mobile phone

Corded Headsets



HW251N-Monaural
HW261N-Binaural

Supra Plus®

Winning combination of great audio performance and reliability

- Wide choice of models – to meet personal preferences; monaural or binaural, voice-tube or noise-cancelling
- Single cable binaural – for complete comfort and convenience
- QuickCall feature – allows you to take a call quickly and easily
- Robust design and construction – for exceptional reliability



HW291N-Monaural
HW301N-Binaural

EncorePRO™

Premium audio, comfort and styling for high quality customer conversations

- Enhanced noise-cancelling, and wideband audio -give you clearer conversations with your customers enabling you to offer a better service
- Distinctive, unique design – provide high performance and a stylish look
- VoIP ready – through the use of enhanced echo control and wideband audio, allows you to preserve your investment through future phone system upgrades
- Seven axes of adjustability – ensure you can wear the headset in the most comfortable and effective position



HW111N-Monaural
HW121N-Binaural

Entera™

An entry level headset with limited features, available in a monaural style that can be worn on either ear or binaural, to block out background noise

- Noise reducing microphone for improved intelligibility
- Choose the monaural style to confer with colleagues or the binaural style to block out background noise
- Wideband audio to help you preserve investment when moving to VoIP
- Comfortable and lightweight

Corded Headsets



UC Standard version:
C310-Monaural
C315 (monaural, leatherette/foldable) **NEW**
C320-Binaural
C325 (stereo, leatherette/foldable ear cushions) **NEW**
Microsoft version:
C310-M (monaural, foam ear cushions)
C315-M (monaural, leatherette/foldable ear cushions) **NEW**
C320-M (stereo, foam ear cushions)
C325-M (stereo, leatherette/foldable ear cushions) **NEW**



UC Standard version: C435
Microsoft version : C435M



UC Standard version:
C510-Monaural
C520-Binaural
Microsoft version:
C510M-Monaural
C520M-Binaural

Blackwire 300

The best-featured UC headset you never thought your budget could afford

Lightweight metal headband offers durability and a customizable, comfortable fit

- Intuitive inline controls to answer/end calls, control volume, and mute
- Smartly placed indicator lights and helpful audio alerts give call, mute, and volume status
- Dynamic EQ feature automatically adjusts audio for voice or multimedia use
- Noise-canceling microphone filters out background sound
- Enhanced Digital Signal Processing (DSP) provides a more natural sounding voice
- Wideband audio with noise cancelling for high quality PC telephony
- SoundGuard® technology provides protection against audio spikes

Blackwire 435

Enjoy crystal-clear PC audio anywhere work happens

- Folds flat for easy mobility
- A soft travel carrying case which provides extra protection and cord management
- Noise-cancelling microphone limits outside noise interruptions, ensuring excellent audio quality and easing listener fatigue
- Echo cancellation for full-duplex speakerphones when both the microphone and speaker are on at the same time
- Hi-Fi audio with stereo sound optimises music and video quality
- Wideband microphone provides the best PC audio telephony available
- Microphone, soft ear cushions, and a soft headband adjusts for perfect fit and extended wear
- Total-focus sound reduction in a binaural design
- SoundGuard™ protects against instantaneous sound spikes above 118dB

Blackwire 500 Series

Ideal for all-day use, long conference calls, and listening to multi-media

- Smart Sensor™ technology lets you answer a call by simply putting on the headset
- One-touch call answer/end, vol +/-, and mute
- Inline indicator lights and user friendly audio alerts the user to connection, mute and volume status
- Dynamic EQ automatically adjusts audio settings between voice calls and music
- PC wideband audio with noise-canceling microphones for high-quality PC telephony
- Digital Signal Processing (DSP) provides natural voice sound
- SoundGuard® technology provides protection against audio spikes
- Ultra-soft leatherette ear cushions and lightweight headband provide all day comfort
- Take it on the go, with folding ear cushions and included carrying case

Corded Headsets



UC Standard version:
C710-Monaural
C720-Binaural
Microsoft version:
C710M-Monaural
C720M-Binaural

Blackwire 700 series

Corded reliability meets wireless flexibility

This versatile UC headset is for workers who need high-quality PC audio and seamless Bluetooth® connectivity to mobile phones and tablets – It's a singular solution that combines corded reliability with wireless flexibility.

- Premium UC headset seamlessly manages calls to and from your PC and mobile devices
- Smart Sensor™ technology lets you answer a call by simply putting on the headset
- Detachable cable with integrated clothing clip to take your mobile calls throughout the office
- Dynamic EQ automatically adjusts audio settings between voice calls and music
- PC wideband audio with noise-cancelling microphones for high-quality PC telephony
- Digital Signal Processing (DSP) provides natural voice sound

Calisto products



P825, P825M (PC + mobile phone + wireless mic)
P835, P835M (PC + mobile phone + home landline + wireless mic)

Calisto® 800

Experience a whole new way to manage your PC, mobile and home* phone calls with the Calisto® 800 Series multi-device speakerphone system.

- 2.4" colour display and touch sensitive keys for intuitive visual call management
- Premium sound with full duplex wideband audio support and advanced noise cancellation
- User friendly Caller ID and call log
- Bright, backlit LCD displays incoming caller ID, time, and user's online status/presence
- Wireless microphone offers unparalleled voice transmission and freedom of movement **
- ** Comes standard with Calisto 825 and 835. Sold separately with Calisto 820 and 830.



P240: UC Standard version
P240M: Version optimized for Microsoft®

Calisto® 240

Make the evolution to PC communications simple with the new Calisto® 240 USB handset.

- A familiar phone interface for managing PC calls.
- Integrated full duplex speakerphone for hands-free convenience.
- LCD screen for easy call ID viewing and menu navigation.
- Answer/end/mute/dial/redial controls at your finger tips.
- Wideband offers the best PC audio available.
- Slim, portable design easily fits into laptop bag.
- Enhanced protection with included carrying pouch.
- SoundGuard® technology provides protection against audio spikes.
- Powered by USB, no batteries required.



P620: UC Standard version
P620M: Version optimized for Microsoft®

Calisto® 620

The first wireless speakerphone designed for UC, Calisto® 620 seamlessly integrates calls from your laptop, smartphone, or tablet in a portable solution that sounds great and sets up easily – all without cords or fuss.

- Simplified call management with an easy interface for call answer/end, mute and volume on PC, smartphone or tablet
- Bluetooth® mini USB adapter for always-ready PC connectivity
- Talk-time up to 7 hours, standby time up to 5 days
- Intelligent bi-directional microphones activate in the direction of the speaker's voice
- 360-degree room coverage with active background noise cancellation
- PC wideband audio and Digital Signal Processing reduces drop-outs and echo
- Full duplex audio support creates natural rich sound
- Integrated A2DP lets you listen to streaming media from your mobile device
- Compact, wireless design goes anywhere with included soft carrying case

Audio processors & UC Enabler



Vista™ M22™

Better sound quality and enhanced intelligibility

- Maintains volume – at the user chosen level regardless of incoming call volume
- Outbound noise reduction – enhances the performance of all Plantronics headsets to reduce the background noise a caller hears
- Incoming noise reduction – lowers incoming noise to enhance the agents listening comfort



VistaPlus™ AP15 / DM15 / M15D

Digital Audio Processor for complete protection against acoustic incidents

- SoundGuard Digital™ provides acoustic incident protection by removing sudden, loud sounds, and controlling daily personal noise exposure to comply with legislation (DM15 only)
- CallClarity Digital™ delivers optimum sound quality, including automatic volume leveller (DM15 only)
- Volume, mute and tone controls, with headset/handset switch
- Compatible with all major business phone systems



DA series DA40™, DA45™, DA55™ (not pictured) or DA60™

Harness the power of Unified Communications

- Works with all Plantronics H-series headsets to provide quality audio, reliability, and a choice of wearing styles
- Echo suppression ensures natural conversation even with VoIP latency (DA45 only)
- Enables easy call answer/end feature on most softphones, via Plantronics software (DA45 only)
- Enhances contact centre agent experience via Plantronics software (DA60 only)



UC Enabler MDA200

Designed to solve the communications challenges of businesses migrating to Unified Communications, the MDA200™ makes it easy to manage PC voice and multi-media, while maintaining connectivity to your desk phone.

- Allows the choice of one corded or wireless USB headset for users in the office or on-the-go
- Simple user interface to easily answer, end, hold and switch between desk phone and PC calls
- Supports remote call control with Plantronics corded and wireless USB headsets
- Manage calls from PC, desk phone and even a mobile phone when used with Bluetooth USB headsets (like Voyager™ PRO UC)
- Compatible with Plantronics corded desk phone headsets when used with a USB adapter

plantronics®
AtlasPhones.com