

Grandstream Networks, Inc.

WP820

Enterprise Portable Wi-Fi Phone

User Guide



COPYRIGHT

©2019 Grandstream Networks, Inc. <http://www.grandstream.com>

All rights reserved. Information in this document is subject to change without notice. Reproduction or transmittal of the entire or any part, in any form or by any means, electronic or print, for any purpose without the express written permission of Grandstream Networks, Inc. is not permitted.

The latest electronic version of this guide is available for download here:

<http://www.grandstream.com/support>

Grandstream is a registered trademark and Grandstream logo is trademark of Grandstream Networks, Inc. in the United States, Europe and other countries.

CAUTION

Changes or modifications to this product not expressly approved by Grandstream, or operation of this product in any way other than as detailed by this guide, could void your manufacturer warranty.

WARNING

Please do not use a different power adaptor with devices as it may cause damage to the products and void the manufacturer warranty.



FCC warning

This device complies with part 15 of the FCC Rules. Operation is subject to the following two conditions:

(1) The device may not cause harmful interference, and (2) This device must accept any interference received, including interference that may cause undesired operation.

Changes or modification not expressly approved by the party responsible for compliance could void the user's authority to operate the equipment. This equipment has been tested and found to comply with limits for a Class B digital device, pursuant to Part 15 of the FCC Rules.

These limits are designed to provide reasonable protection against harmful interference in a residential installation. This equipment generates uses and can radiate radio frequency energy and, if not installed and used in accordance with instructions, may cause harmful interference to radio communications. However, there is no guarantee that interference will not occur in a particular installation. If this equipment does cause harmful interference to radio or television reception, which can be determined by turning the equipment off and on, the user is encouraged to try to correct the interference by one or more of the following measures:

- Reorient or relocate the receiving antenna.
- Increase the separation between the equipment and receiver.
- Connect the equipment into an outlet on a circuit different from that to which the receiver is connected.
- Consult the dealer or an experienced radio/TV technician for help.

RF Radiation Exposure Statement (SAR)

This equipment complies with FCC RF radiation exposure limits set forth for an uncontrolled environment. This transmitter must not be co-located or operating in conjunction with any other antenna or transmitter.

CE Authentication

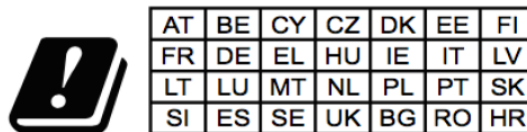

In all EU member states, operation of 5150 - 5350 MHz is restricted to indoor use only.

Hereby, Grandstream Networks, Inc. declares that the radio equipment WP820 is in compliance with Directive 2014/53/EU.

The full text of the EU declaration of conformity is available at the following internet address:
<http://www.grandstream.com/support/resources/>

SPECIFICATION

Operating Frequency Band(RF):

BT: 2402-2480MHz(TX&RX)

BLE: 2402-2480MHz(TX&RX)

2.4GHz WIFI: 2412-2472MHz(TX&RX)

5GHz WIFI: 5150-5250MHz,5250-5350MHz,5470-5725MHz(TX&RX)

Max. Of Transmit Power:

BT: 9.55dBm

BLE: 2.45dBm

2.4GHz WIFI:

802.11b:19.78dBm;802.11g:18.12dBm;

802.11n20:18.91dBm;802.11n40:18.39dBm;

5GHz WIFI:

5150-5250MHz:

802.11a:16.93dBm;802.11n20:17.49dBm;802.11n40:16.40dBm

5250-5350MHz:

802.11a:15.69dBm;802.11n20:15.53dBm;802.11n40:15.46dBm

5470-5725MHz:

802.11a:16.42dBm;802.11n20:16.63dBm;802.11n40:15.82dBm



GNU GPL INFORMATION

WP820 firmware contains third-party software licensed under the GNU General Public License (GPL). Grandstream uses software under the specific terms of the GPL. Please see the GNU General Public License (GPL) for the exact terms and conditions of the license.

Grandstream GNU GPL related source code can be downloaded from Grandstream web site from:
<http://www.grandstream.com/support/faq/gnu-general-public-license/gnu-gpl-information-download>



Table of Contents

DOCUMENT PURPOSE	17
CHANGE LOG	18
Firmware Version 1.0.7.7	18
Firmware Version 1.0.5.5	18
Firmware Version 1.0.3.20	18
Firmware Version 1.0.3.6	19
Firmware Version 1.0.3.5	19
Firmware Version 1.0.1.15	20
Firmware Version 1.0.1.12	20
GUI INTERFACE EXAMPLES	21
WELCOME	22
PRODUCT OVERVIEW	23
Feature Highlights	23
Technical Specifications	23
GETTING STARTED	25
Equipment Packaging	25
Setting up the WP820	26
<i>Charging Station</i>	26
<i>Handset</i>	26
<i>Battery Information</i>	27
WP820 Handset Keys Description	27
WP820 Icons Description	29
WP820 LED Status	31
WP820 Handset Menu	31
WP820 Keypad	34



WP820 WEB GUI ACCESS CONFIGURATION 37

Configuration via Web Browser	37
<i>Accessing the Web UI</i>	37
<i>Web GUI Languages</i>	38
<i>Saving the Configuration Changes</i>	38
Web UI Access Level Management	38
<i>Changing User Level Password</i>	38
<i>Changing Admin Level Password</i>	39
<i>Changing HTTP / HTTPS Web Access Port</i>	40

BASIC OPERATIONS 42

WP820 Home Screen	42
Turning the Handset ON/OFF	43
Connecting WP820 to Wi-Fi Network	43
<i>Auto Connection</i>	43
<i>Manual connection</i>	43
<i>Wi-Fi Band Configuration</i>	44
<i>Wi-Fi Signal Warning Configuration</i>	44
<i>Wi-Fi Roaming Mode Configuration</i>	45
Connecting WP820 to Bluetooth Devices	46
<i>Turn On/Off Bluetooth</i>	46
<i>Change Bluetooth Device Name</i>	46
<i>Pair WP820 with a Bluetooth Device</i>	46
<i>Unpair a Bluetooth Device</i>	47
<i>Connect to a Bluetooth Device</i>	48
<i>Connect to a Bluetooth Device from Web Interface</i>	48
<i>Turn On/Off Bluetooth</i>	48
<i>Change Bluetooth Device Name</i>	48
<i>Pair WP820 with a Bluetooth Device</i>	49
Checking WP820 Status	49
<i>WP820 Account Status</i>	49



WP820 Network Status	50
WP820 System Info	51
WP820 Network Statistics	52
WP820 Battery.....	53
Screen Lock	54
<i>Setting the Key Lock from Handset</i>	54
<i>Lock Screen Settings from Web GUI</i>	54
<i>Locking/Unlocking the Screen</i>	55
Configuring the LCD Brightness and Screen Timeout.....	56
Return to Idle Screen	56
Register a SIP Account.....	56
<i>Register Account via Web User Interface</i>	56
<i>Register Account via LCD Menu</i>	57
Guest Login.....	58
<i>Configuration</i>	58
<i>User Login</i>	59
<i>User Logout</i>	60
PHONE SETTINGS.....	61
Selecting Phone Language.....	61
Activate/Deactivate Hands-Free Mode	61
Muting the Microphone	61
Adjusting Speaker and Earpiece Volume	62
Ringtones.....	62
<i>Setting the Ringer Volume on the WP820</i>	62
<i>Setting the Ringtones on the WP820</i>	63
Date and Time.....	63
Wallpaper Customization	64
<i>Applying Uploaded Wallpaper</i>	65
<i>Deleting Wallpaper</i>	67
Reboot the WP820.....	67



CALL OPERATIONS 68

Placing calls	68
<i>Make a Call using a Line</i>	68
<i>Dialing from Call history</i>	69
<i>Dialing from Phonebook</i>	70
Answering Calls	70
Auto Answer	70
Ending Calls	72
Rejecting Calls	72
Call Hold/Resume	72
Call Waiting	72
Do Not Disturb	73
Call Forward	73
Call Transfer	75
<i>Blind Transfer</i>	75
<i>Attended Transfer</i>	75
Speed Dial	77
3-Way Conference	78
UCM Conference	78
<i>Participate in UCM Conference Room</i>	78
<i>Conference Call Operations</i>	79
<i>CEI (Conference Event Indicator)</i>	81
Voice Mail	82
<i>Set Voice Mail ID</i>	82
<i>Play Voice Mail Messages</i>	83

CONTACTS 85

Local Contacts	85
LDAP	86
Groups	87
Blacklist	87



BROADSOFT XSI.....	88
CALL HISTORY	89
Dial Out from Call History	89
Call History Options	89
Call History Details.....	90
SMS	91
View SMS.....	91
Create SMS	91
Delete SMS.....	92
CALL FEATURES.....	93
MULTI-FUNCTION BUTTON	94
PTT/Paging	94
SAFE/Panic Call	94
Mute/Un-mute	94
Speed dial	94
PTT (PUSH-TO-TALK) FUNCTIONALITY.....	95
Enabling PTT mode on the WP820	95
Using the PTT Functionality on the WP820.....	96
PTT Configuration Settings.....	97
<i>Settings</i>	97
<i>PTT Parameters</i>	97
Group Paging.....	98
<i>Enabling Group Paging Feature</i>	98
<i>Group Paging Parameters</i>	100
IGMP Settings.....	101
SAFE/PANIC CALL	102
Safe Monitoring Features	102
Panic Call Feature	103



WP820 GESTURE AND INTELLIGENT CONTROL	105
Intelligent Control	105
Gesture Control.....	105
<i>Flip Phone</i>	105
<i>Pick Up</i>	106
CONNECTING WP820 TO GDS3710 DOOR SYSTEM	108
DIAGNOSTICS	109
LCD Diagnostics	109
LCD Off	109
LED Diagnostics	110
Keypad Diagnostics	110
Audio Loopback	111
Acceleration sensor	112
Proximity sensor	112
Vibration diagnostics	112
Certificate Verification	113
Traceroute.....	113
Ping.....	114
Nslookup	114
One-click Debugging.....	114
UPGRADING AND PROVISIONING	117
Upgrade and Provisioning Configuration.....	117
<i>Configure via keypad Menu</i>	117
<i>Configure via Web GUI</i>	118
Upload Firmware Locally	118
No Local Firmware Servers	119
Firmware Upgrade via USB	119
Config Provision via USB.....	120
Wi-Fi Provision via USB.....	121



Provisioning and Configuration File Download	121
FACTORY RESET	122
Restore to Factory Default via LCD Menu	122
Restore to Factory Default via the Web GUI	122
Restore to Factory Default using Hard Keys	123
Quick Setup Wizard	123
EXPERIENCING WP820 ENTERPRISE PORTABLE WI-FI PHONE.....	124



Table of Tables

Table 1: WP820 Features at a Glance	23
Table 2: WP820 Technical Specifications	23
Table 3: Equipment Packaging	25
Table 4: WP820 Description.....	28
Table 5: WP820 Icons Description	29
Table 6: WP820 LED Status.....	31
Table 7: WP820 Account Status Description.....	49
Table 8: WP820 Network Status Description	50
Table 9: WP820 System Info Description.....	51
Table 10: WP820 Network Status Description	52
Table 11: WP820 Battery Description	53
Table 12: New Contact Parameters	86
Table 13: Call Features	93
Table 14: SAFE Monitoring Settings	103
Table 15: Panic/Emergency Call Settings	104



Table of Figures

Figure 1: WP820 Package Content	25
Figure 2: Charging Station	26
Figure 3: WP820 Handset Setup	26
Figure 4: WP820 Description	28
Figure 5: WP820 Keypad Modes	34
Figure 6: WP820 Web GUI Language	38
Figure 7: User Level Password	39
Figure 8: Admin Level Password	40
Figure 9: Web/SSH access	41
Figure 10: Home screen pages	42
Figure 11: Default Wi-Fi Network	43
Figure 12: Connecting WP820 to Wi-Fi Network	44
Figure 13: Wi-Fi Band configuration	44
Figure 14: Wi-Fi Signal Warning Sensitivity	45
Figure 15: Wi-Fi Roaming Mode	45
Figure 16: Make calls using Bluetooth account	47
Figure 17: Pair WP820 to a Bluetooth Device	47
Figure 18: Bluetooth profile	48
Figure 19: Connect to a Bluetooth device	48
Figure 20: WP820 Account Status	49
Figure 21: WP820 Network Status	50
Figure 22: System Info	51
Figure 23: WP820 Network Status	52
Figure 24: WP820 Battery	53
Figure 25: Keypad lock from handset	54
Figure 26: Lock Screen Settings	55
Figure 27: Unlock Keypad	55
Figure 28: LCD Display Configuration	56
Figure 29: Account Status	57
Figure 30: SIP Accounts Configuration	58
Figure 31: Guest Login settings	59
Figure 32: Guest Login Window	60
Figure 33: Guest Logout	60
Figure 34: Configuring Phone Language	61
Figure 35: Muting the Microphone	62
Figure 36: Ringer Volume	63
Figure 37: Calls Default Ringtone	63
Figure 38: Date and Time Settings	64
Figure 39: Wallpaper Settings	64
Figure 40: Wallpaper - Display Mode	65



Figure 41: Wallpaper - Uploaded	65
Figure 42: Switching Wallpaper from Handset.....	66
Figure 43: Switching Wallpaper from Web GUI	66
Figure 44: Deleting Wallpaper.....	67
Figure 45: Reboot the WP820	67
Figure 46: Dialing from Call History	69
Figure 47: Dialing from Contacts List.....	70
Figure 48: Auto-answer on WP820	71
Figure 49: Auto-answer Idle Screen.....	71
Figure 50: Hold/Unhold Calls	72
Figure 51: Call Waiting	73
Figure 52: DND Enabled	73
Figure 53: Call Forwarding.....	74
Figure 54: Blind Transfer	75
Figure 55: Attended transfer options	76
Figure 56: Attended transfer.....	76
Figure 57: Split Calls	76
Figure 58: Speed Dial Configuration	77
Figure 59: 3-way Conference Call	78
Figure 60: Join UCM Conference Room.....	79
Figure 61: UCM Conference Participants	79
Figure 62: Send meeting invitation	80
Figure 63: Kick a participant.....	80
Figure 64: Member has joined notification	81
Figure 65: Member Mute notification	81
Figure 66: Member left notification.....	82
Figure 67: LCD Menu - Voice Mail ID	83
Figure 68: Web UI - Voice Mail Access Number	83
Figure 69: Playing Voicemail Messages	84
Figure 70: Accessing Contacts.....	85
Figure 71: Create a new contact.....	85
Figure 72: Create New Group	87
Figure 73: Blacklist.....	87
Figure 74: BS XSI Login.....	88
Figure 75: WP820 Call History.....	89
Figure 76: Call History Options	89
Figure 77: WP8200 Call History Details.....	90
Figure 78: View SMS Dialog	91
Figure 79: Create a New Message	91
Figure 80: send a New Message from Contact.....	92
Figure 81: Enabling PTT Feature on WP820.....	95
Figure 82: PPT Channel.....	96



Figure 83: PTT Call (Caller)	96
Figure 84: PTT Call (Callee)	97
Figure 85: PTT Call Release	97
Figure 86: Enabling Group Paging.....	99
Figure 87: IGMP setting	101
Figure 88: Intelligent Control Features.....	105
Figure 89: Flip Phone.....	106
Figure 90: WP820 Gesture Control (Flip phone)	106
Figure 91: Pick up	107
Figure 92: WP820 Gesture Control (Pick up)	107
Figure 93: WP820 Connected to GDS3710.....	108
Figure 94: Diagnostics APP	109
Figure 95: LCD Diagnostics	109
Figure 96: LCD Diagnostics	110
Figure 97: LED Diagnostics	110
Figure 98: keypad Diagnostics.....	111
Figure 99: Audio Loopback	111
Figure 100: Acceleration sensor	112
Figure 101: Proximity sensor	112
Figure 102: Vibration diagnostics.....	113
Figure 103: Certificate Verification	113
Figure 104: Traceroute.....	113
Figure 105: Ping.....	114
Figure 106: Nslookup	114
Figure 107: one-click debugging	115
Figure 108: select debug mode and start capture	115
Figure 109: select debug mode and start capture	115
Figure 110: export or delete debug file	116
Figure 111: WP820 Upgrade Configuration via Keypad Menu	117
Figure 112: WP820 Upgrade Configuration via Web GUI.....	118
Figure 113: Upload Firmware File to Update	119
Figure 114: USB disk connected.....	120
Figure 115: New Firmware Detected	120
Figure 116: WP820 LCD - Confirm Factory Reset.....	122
Figure 117: WP820 Web GUI - Factory Reset.....	122
Figure 118: WP820 Web GUI - Confirm Factory Reset.....	123
Figure 119: Setup wizard	123



DOCUMENT PURPOSE

This document describes how to use WP820 Enterprise Portable Wi-Fi phone. To learn the advanced functions of WP820, please visit <http://www.grandstream.com/support> to download the latest “WP820 Administration Guide”.

This guide covers following topics:

- [Product Overview](#)
- [Getting Started](#)
- [WP820 Web GUI Access Configuration](#)
- [Basic Operations](#)
- [Phone Settings](#)
- [Call Operations](#)
- [Contacts](#)
- [Call History](#)
- [SMS](#)
- [Call features](#)
- [Multi-Function Button](#)
- [PTT \(Push-to-Talk\) Functionality](#)
- [SAFE/Panic Call](#)
- [WP820 Gesture and Intelligent Control](#)
- [Connecting WP820 to GDS3710 Door System](#)
- [Upgrading and Provisioning](#)
- [Factory Reset](#)
- [Experiencing WP820 Enterprise Portable Wi-Fi Phone](#)



CHANGE LOG

This section documents significant changes from previous firmware versions. Only major new features or major document updates are listed here. Minor updates for corrections or editing are not documented here.

Firmware Version 1.0.7.7

- Added support for Finnish and Hebrew language.
- Added detection for upgrade fail if speed lower than 1B/s for 120 secs for all modes.
- Added ability to configure outbound proxy from LCD menu. [Register Account via LCD Menu]
- Added USB icon display on status bar when USB drive is plugged. [Firmware Upgrade via USB]
- Added Broadsoft XSI support. [CONTACTS]
- Added “One-click Debugging” feature on handset UI. [DIAGNOSTICS]
- Added SN info on LCD and web UI. [WP820 System Info]

Firmware Version 1.0.5.5

- Added battery status. [WP820 Battery]
- Added Bluetooth interface on web UI. [Bluetooth]
- Added visual voicemail function. [Voice Mail]
- Added custom wallpaper support on web UI. [Wallpaper Customization]
- Added Wi-Fi provision via USB. [Wi-Fi Provision via USB]
- Added config file provision via USB. [Config Provision via USB]
- Added lock screen feature from web UI and screen lock password. [Screen Lock]
- Added UCM conference screen to show participants count info. [UCM Conference]
- Added send message in contacts UI. [SMS]
- Added speed dial option for multi-purpose key. [MULTI-FUNCTION BUTTON]
- Added phone support for clicking ok button to accept call.

Firmware Version 1.0.3.20

- Added video call zoom function in door system integration feature with GDS. [CONNECTING WP820 TO GDS3710 DOOR SYSTEM]
- Added ability to enable/disable SSH access without requiring reboot. [Web/SSH Access]
- Added support for UCM conference control. [UCM Conference]
- Added support for quick search mode in contacts application. [CONTACTS]
- Added ability to disable web UI access. [Accessing the Web UI]
- Added ability to disable Low Wi-Fi signal warning. [Wi-Fi Signal Warning Configuration]
- Added quick setup wizard module. [Quick Setup Wizard]
- Updated attended transfer confirmation msg. [Attended Transfer]
- Increased dial digit limit to 30 characters. [Placing calls]
- Removed “Personalized Account” menu and moved related options to Settings → Call settings. [WP820 Handset Menu]



- Added Wi-Fi restart when changed Wi-Fi frequency. [Wi-Fi Band Configuration]
- Added support for connected Bluetooth device display. [Connecting WP820 to Bluetooth Devices]
- Added Bluetooth headset mode support. [Connecting WP820 to Bluetooth Devices]
- Updated device LCD language supported list. [Selecting Phone Language]
- Updated SMS interface. [SMS]
- Add 2 second delay when detect flip to reject call. [Flip Phone]
- Updated factory reset using hard key interface when constraint mode enabled. [Restore to Factory Default using Hard Keys]
- Added support for factory reset to first unregister sip message without contact head. [FACTORY RESET]
- Updated SRTP icon to display only when signaling and media are both encrypted. [WP820 Icons Description]

Firmware Version 1.0.3.6

- Changed voicemail notification from “Ordinary” to “Normal”. [WP820 Icons Description]

Firmware Version 1.0.3.5

- Supported TLSv1.2. [Technical Specifications]
- Added Slovak language support on LCD display. [Technical Specifications]
- Added warning tone when device is low on battery. [Battery Information]
- Added auto bootup when placed on charger after an abnormal power off. [Battery Information]
- Added Calculator application. [WP820 Handset Menu]
- Added additional Home screen on the left and the right. [WP820 Home Screen]
- Added support for captive portal. [Manual connection]
- Added Wi-Fi Band selection. [Wi-Fi Band Configuration]
- Added warning and message prompt when Wi-Fi signal is weak. [Wi-Fi Signal Warning Configuration]
- Added beep tone during a call when Wi-Fi connection is lost. [Wi-Fi Signal Warning Configuration]
- Added support for captive portal. [Wi-Fi Roaming Mode Configuration]
- Improved time and date display for different format. [Date and Time]
- Added support for troubleshooting tools. [Diagnostics]
- Changed incoming call softkey options from “Accept, Transfer, Reject” to “Accept, Transfer, Mute” for user friendly purpose. [CALL OPERATIONS]
- Added stutter tone at dialing interface when account has un-read voicemails. [Voice Mail]
- Added support for quick conference during call. [3-Way Conference]
- Increased contacts max limit count to 1000. [CONTACTS]
- Improved SMS UI and UX. [SMS]
- Added prompt for message sending status after users click on “Send”. [SMS]
- Added setting IGMP Keep Alive for PTT/Paging feature. [IGMP Settings]
- Add support for SAFE/Panic Call mode. [SAFE/PANIC CALL]
- Added Gesture Control features. [Gesture Control]
- Improved Phone User interface for user friendly purpose.



Firmware Version 1.0.1.15

- Adding show storage status in System Info. [WP820 System Info]

Firmware Version 1.0.1.12

- This is the initial version for WP820.



GUI INTERFACE EXAMPLES

http://www.grandstream.com/sites/default/files/Resources/WP820_web_gui.zip

1. Screenshot of Login page
2. Screenshots of Status pages
3. Screenshots of Account pages
4. Screenshots of Phone Settings pages
5. Screenshots of System Settings pages
6. Screenshots of Maintenance pages
7. Screenshots of Application pages
8. Screenshots of Value-added Service pages



WELCOME

Thank you for purchasing Grandstream WP820. This powerful Enterprise Portable Wi-Fi Phone features dual-band 802.11a/b/g/n Wi-Fi, supports Wi-Fi roaming, and integrated Bluetooth. The combination of advanced telephony features and durability make it ideal for mobilizing your VoIP network in residences, warehouses, retail stores, hotels and many more environments. Due to a durable design, this sleek phone is drop safe from 1.2 meters, with 150 hours standby time and 7.5 hours talk time making it an ideal addition for homes and businesses alike.



PRODUCT OVERVIEW

Feature Highlights

The following table contain the major features of the WP820:

Table 1: WP820 Features at a Glance

 <p>WP820</p>	<ul style="list-style-type: none"> • 2 SIP accounts and 2 lines. • 3-way audio conference calls. • Dual-band 802.11a/b/g/n Wi-Fi. • Wi-Fi roaming and integrated Bluetooth. • 150 hours standby time. • 7.5 hours talk time.
---	--

Technical Specifications

The following table resumes all the technical specifications including the protocols/standards supported, voice codecs, telephony features, languages and upgrade/provisioning settings for the Base station WP820.

Table 2: WP820 Technical Specifications

Protocols/Standards	SIP RFC3261, TCP/IP/UDP, RTP/RTCP, HTTP/HTTPS, ARP, ICMP, DNS (A record, SRV, NAPTR), DHCP, SSH, TFTP, NTP, STUN, SIMPLE, TR-069, 802.1x, TLS, SRTP, IPv6
Voice Codecs and Capabilities	Support for G.711 μ /a, G.729A/B, G.722 (wide-band), iLBC, Opus, in-band and out-of-band DTMF (In audio, RFC2833, SIP INFO), VAD, CNG, AEC, PLC, AJB, AGC, ANS
Graphic Display	2.4-inch (240x320) TFT color LCD
Peripherals	3 soft keys, 3 function keys: Volume up, volume down, Push to Talk key, navigation keys, dial, hang-up, speakerphone, phonebook, backlit keypad, proximity sensor, accelerator, vibration motor
Push-to-Talk	Customizable button for push-to-talk, panic call and other related functions
Bluetooth	Yes, Bluetooth v4.2
Auxiliary Ports	3.5 mm headset jack, Micro-USB port for charging, dual-MIC, dual-color LED.
Telephony Features	Hold, transfer, forward, 3-way audio conference, downloadable phonebook (XML, up to 1000 items), call waiting, call log (up to 100 records), off-hook auto dial, auto answer, click-to-dial, flexible dial plan, hot desking, personalized music ringtones and music on hold, server redundancy and fail-over, push to talk



Security	User and administrator level passwords, MD5 and MD5-sess based authentication, 256-bit AES based secure configuration file, SRTP, TLS, 802.1x media access control
HD Audio	Yes, both on handset and speakerphone with support for wideband audio, HAC supported
QoS	802.11e and Layer 3 (ToS, DiffServ, MPLS) QoS
Multi-language	English, Arabic, Chinese, Czech, Dutch, German, French, Hebrew, Italian, Japanese, Polish, Portuguese, Russian, Spanish, Turkish, Slovak and more
Upgrade/ Provisioning	Firmware upgrade via TFTP/HTTP/HTTPS, manual upload, mass provisioning using TR-069 or encrypted XML configuration file, manual upload, USB upgrade
Power & Green Energy Efficiency	Universal power adapter included Input: 100-240VAC; Output: +5VDC, 1A (5W) 1500mA Li-ion battery, 150h standby time and 7.5h talk time
Physical	Handset Dimensions: 168.5 x 52.5 x 21.8mm Charger cradle dimensions: 76 x 73 x 81mm Handset weight: 161g Handset package weight (not including QIG): 456g
Temperature and Humidity	Operating Temperature: 0~45°C; Operating Humidity: 10~90%(non-condensing) Storage Temperature: -20~60°C; Storage Humidity: 10~90%(non-condensing)
Package Contents	Handset unit, universal power supply, charger cradle, belt clip, 1 Li-ion battery, Quick Installation Guide.
Durability	Drop-safe from 1.2 meters height
Compliance	FCC, CE, RCM



GETTING STARTED

This chapter provides basic installation instructions including the list of the packaging contents and also information for obtaining best performance with the WP820.

Equipment Packaging

Table 3: Equipment Packaging

WP820
<ul style="list-style-type: none"> • 1x Handset unit • 1x Universal power supply 5V • 1x Charger cradle • 1x Belt clip • 1x Rechargeable battery • 1x Quick Installation Guide • 1x GPL Statement

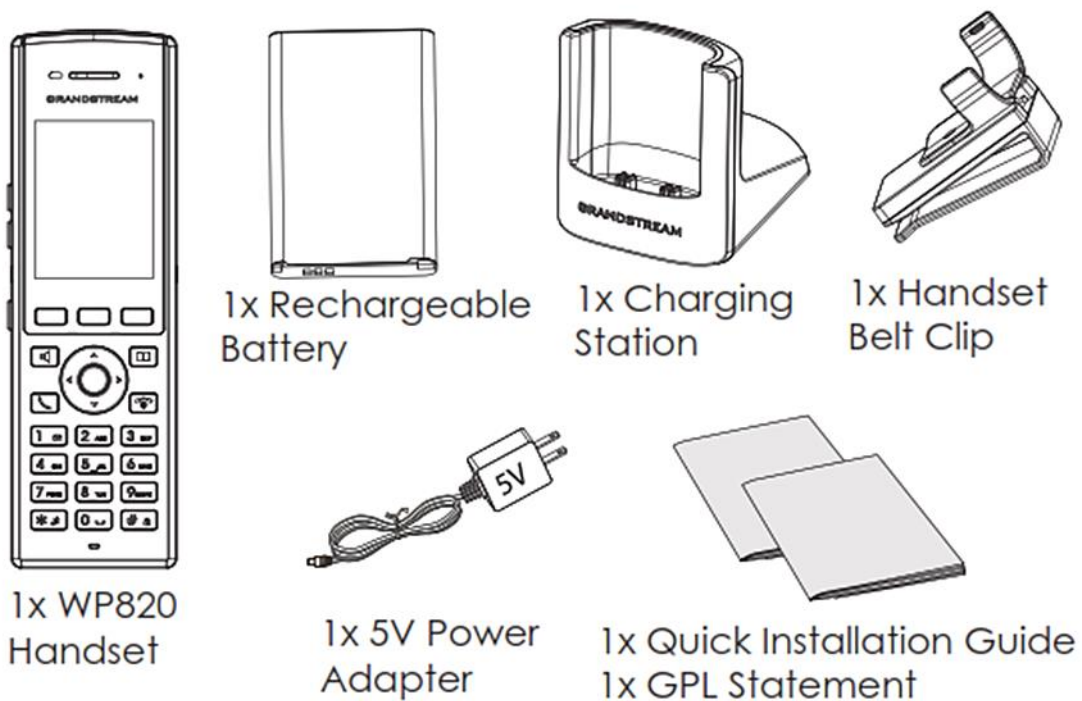

Figure 1: WP820 Package Content

Note: Check the package before installation. If you find anything missing, contact your system administrator.

Setting up the WP820

Charging Station

Plug the power adapter into a power source socket to start using the charging station.

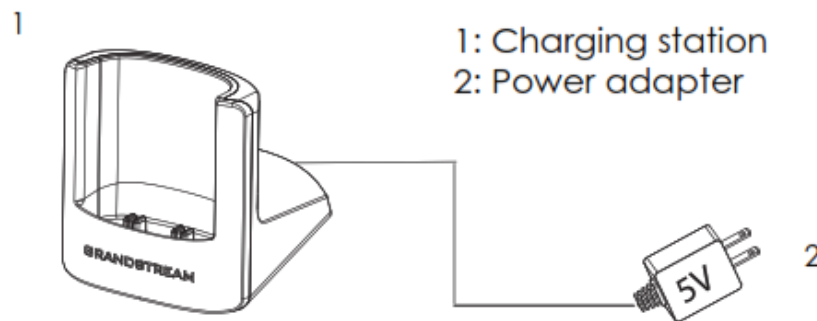

Figure 2: Charging Station

Handset

Please refer to the following steps in order to setup your WP820:

1. Open the battery cover.
2. Insert the battery with the electrodes in the bottom left corner.
3. Close the battery cover.

Note: Please charge the battery fully before using the handset for the first time. (For more information about the battery, please refer to [Battery Information](#).)

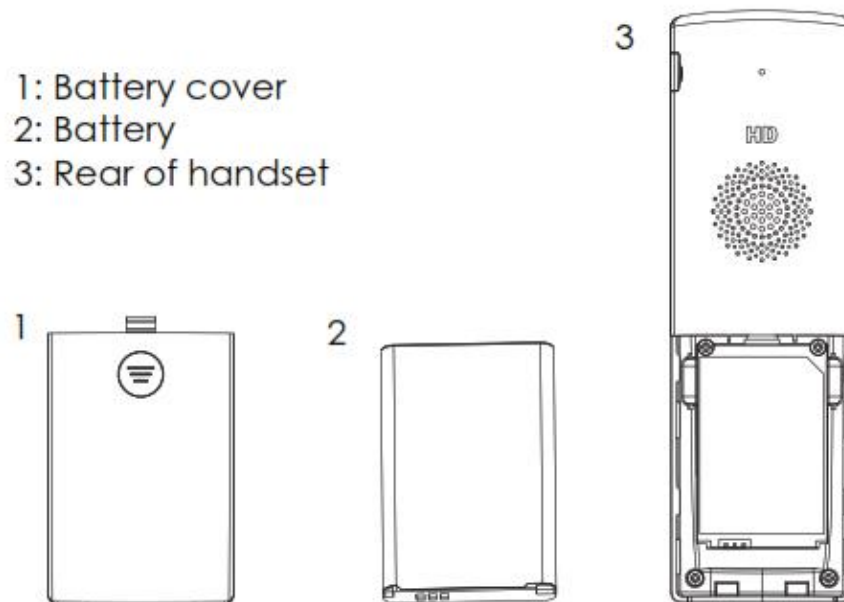

Figure 3: WP820 Handset Setup

Battery Information

- **Technology:** Rechargeable Li-ion Battery
- **Voltage:** 3.8V (Nominal Voltage 3.8V / Limited charge Voltage: 4.35 V)
- **Capacity:** 1500mAh
- **Standby time:** up to 150 hours
- **Talk time:** up to 7.5 hours' active talk time

In order to get the best performance of your WP820, we recommend using original battery provided in the package. The specifications may differ depending on the age and capacity of the battery used.

Notes:

- WP820 Wi-Fi phone generates a warning tone when device's battery level becomes 15% and 5%.
- WP820 auto boots up once placed on charger when device was powered off abnormally (Battery too low, battery removed suddenly, etc..).

Important Note: Be careful when inserting the battery into your handset to avoid any risk of short-circuit, which lead to damage your battery and/or the handset itself. Do not use damaged batteries which can increase the risk of serious harm.

WP820 Handset Keys Description

The WP820 enhances communication and combines usability and scalability in industries such as warehousing, catering and retail as well as in factory settings. The following screenshot describe the WP820 LCD screen and the main hardware components.



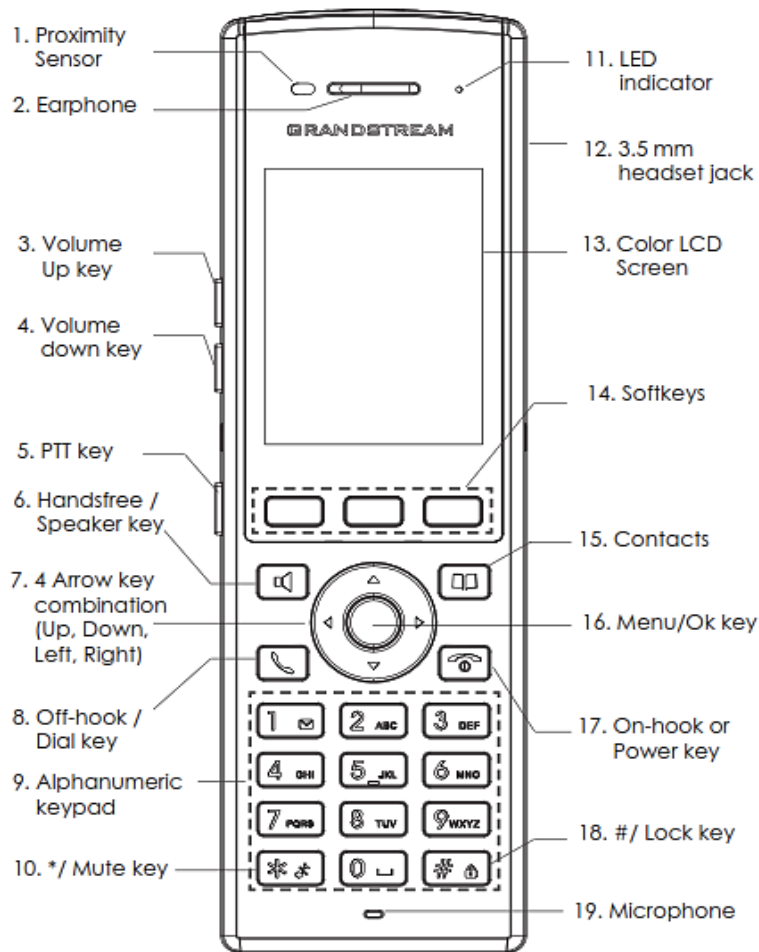

Figure 4: WP820 Description

The following table describes the WP820 keypad keys.

Table 4: WP820 Description



	Key	Description
1.	Proximity sensor	The proximity sensor can detect the presence of a human ear. This sensing is done for two purposes: Reduce display power consumption by turning off the LCD backlight and to avoid inadvertent touches.
2.	Earphone	Delivers audio output.
3,4	Volume up / Down Keys	Configure the handset and ringtone volume.
5.	PTT Key	PTT (Push-to-Talk) button to initiate PTT call. Note: PTT button can also be configured from Web GUI to have other functions such as: SAFE/Panic Call & Mute/Unmute during calls.





















6.	Hands-free / Speaker key	Switches between Handset and Hands-free / Speaker modes.
7.	Arrow key combination (Up, Down, Left, Right)	Allows navigation of the cursor through the displayed menu options.
8.	Off-hook / Dial key	Enters dialing mode, or dials number entered.
9.	Alphanumeric Keypad	Provides the digits, letters, and special characters in context-sensitive applications. For + sign, press and hold key 0.
10.	* / Mute key	Activates or deactivates the mute feature when keep pressing on * in idle screen.
11.	LED indicator	1dual-color LED indicator indicating: power, call, battery, message waiting ...
12.	3.5 mm headset jack	Phone connector for the headphones/headsets.
13.	Color LCD Screen	2.4-inch (240x320) TFT color LCD
14.	Softkeys	Correspond to functions displayed on the LCD. These functions change depending on the current context, and they can be customized on Home screen and Call screen from the Web GUI.
15.	Contacts	Access to contacts list.
16.	Menu/OK key	Selects the option chosen by the cursor or enters the main menu from the home screen.
17.	On-hook or Power key	Terminates calls or turns the handset on / off.
18.	# / Lock key	Locks keypad against unintentional entries when keep pressing #. <ul style="list-style-type: none"> • Press and hold # key for approximately 2 seconds to lock the keys. • Press Unlock softkey and then # to unlock the keys.
19.	Microphone	Picks up audio earpiece and hands-free calls.

WP820 Icons Description

Following table contains description of each icon that might be displayed on the screen of the WP820.

Table 5: WP820 Icons Description

	Battery status Charging
	Wi-Fi not enabled/configured
	Wi-Fi signal status

	Speaker enabled icon
	Ringtone status
	Outgoing Call notification
	Missed Call notification
	Incoming Call notification
	Voicemail notification (Urgent)
	Voicemail notification (Normal)
	Mute enabled icon
	DND enabled icon
	Bluetooth enabled icon
	Bluetooth connected icon
	SRTP & TLS enabled icon
	Contacts
	SMS
	Call History
	Voice Mail
	Diagnostics
	Settings
	Applications
	Status
	Broadsoft XSI

Note: SRTP & TLS enabled icon will be displayed only in case signaling and media are both encrypted.



WP820 LED Status

Table 6: WP820 LED Status

Red Fast Flashing	<ul style="list-style-type: none"> • Upgrading
Green Slow Flashing	<ul style="list-style-type: none"> • Incoming call
Green Blinking	<ul style="list-style-type: none"> • Charging but not full
Green Solid	<ul style="list-style-type: none"> • Charging (full)
Red Slow Flashing	<ul style="list-style-type: none"> • Missed call (s) • New voicemail (s) • New SIP Message (s)
Red Solid	<ul style="list-style-type: none"> • Network disconnected
LED OFF	<ul style="list-style-type: none"> • Normal

WP820 Handset Menu

The handset has an easy-to-use menu structure. Every menu opens a list of options. To open the main menu, unlock first the handset and press “Menu” (softkey in the middle). Press Arrow keys to navigate to the menu option you require. Then press “Select” (left softkey) or **OK/Selection key** to access further options or confirm the setting displayed.

To go to the previous menu item, press “Back” (right softkey). You can press **Power** key at any time to cancel and return to standby mode.



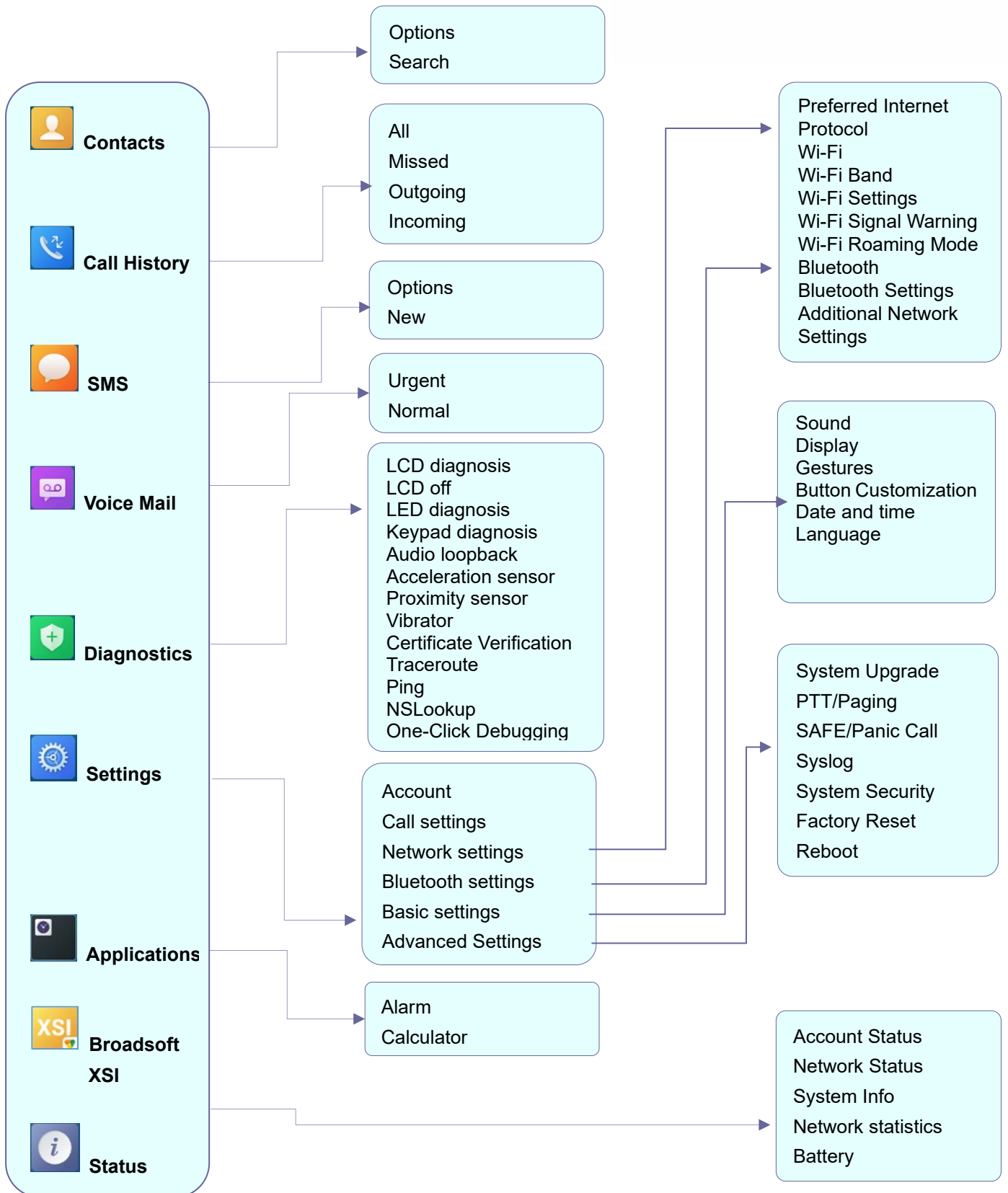

Contacts	Display the list of the registered contacts and also the groups contacts with the ability of searching, adding or editing the entries and also deleting the selected contacts. The maximum number of contacts is 1000.
Call History	Display the call history: Missed Calls , Accepted Calls , Outgoing Calls or All Calls . You can add contacts to Shared Contacts directly from call logs.
SMS	SMS stands for Short Message Service and referred to as a "text message". With a SMS, you can send a message by pressing " New " of up to 160 characters to another device or check the received ones.
Voice Mail	<ul style="list-style-type: none"> • Play Message: Play voice mail messages received. • Set Voice Mail: Configure voice mail parameters.
Diagnostics	<ul style="list-style-type: none"> • LCD diagnosis • LCD off • LED diagnosis • Keypad diagnosis • Audio loopback • Acceleration sensor • Proximity sensor • Vibrator • Certificate Verification • Traceroute • Ping • NSLookup • One-click Debugging
Settings	<ul style="list-style-type: none"> • Account Configure/View SIP accounts settings and account ringtone. • Call settings Configure the account auto answer, call forward, DND and speed dial settings. • Network Settings Configure the networks settings including Wi-Fi settings and additional networks settings. • Bluetooth Settings Configure the Bluetooth settings including discovery, pairing and connection actions. • Basic Settings Configure the basic settings including voice settings, display settings, Gestures and button customization, language settings and date/time settings. • Advanced Settings Configure the advanced settings including system upgrade, PTT/Paging settings, system security settings, syslog settings and factory reset / reboot.



Applications	<ul style="list-style-type: none"> • Alarm Clock: Configures the alarm clock settings • Calculator: performs arithmetic operations on numbers.
Broadsoft XSI	<ul style="list-style-type: none"> • Broadsoft account.
Status	<p>Displays account status, system info, Network status and network statistics</p> <ul style="list-style-type: none"> • Account status. • Network status: Press to enter the sub menu for MAC address, IP setting information (DHCP/Static IP), IPv4 address, IPv6 address, Subnet Mask, Gateway; DNS server and VPN. • System Info: Press to enter the sub menu for Running memory, Storage status, MAC address, System version, Recovery version, U-boot version, Kernel version, Hardware version, PN number, Country code and Running time. • Network Statistics: Press to enter the sub menu for Network SSID, BSSID, IP address, Signal strength, Connection speed, Channel, Frequency, Tx packets, Tx error packets, Tx error rate, Tx drop packets, Tx drop rate, Rx packets, Rx error packets, Rx error rate, Rx drop packets, Rx drop rate. • Battery: Displays the battery status and the battery usage details.

WP820 Keypad

The WP820 keypad can be used by tapping on an input field. WP820 keypad has 4 modes “ABCabc2”, “ABC”, “abc” and “123”. Default mode is “ABCabc2”. **Note:** If the input field is accepting only digits, only “123” mode will be available.

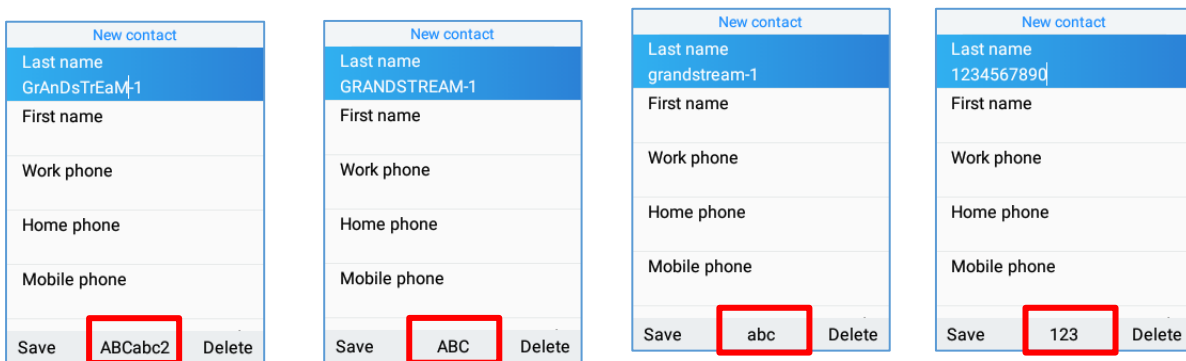

Figure 5: WP820 Keypad Modes

- **“ABCabc2” Mode:**

This mode allows to enter capital letters, small letters, digits and symbolic characters.

Following table describes allowed characters for each key.

Key	Description	Key	Description	Key	Description
1	. , ' ? ! " - 1	2	A B C a b c 2	3	D E F d e f 3
4	G H I g h i 4	5	J K L j k l 5	6	M N O m n o 6
7	P Q R S p q r s 7	8	T U V t u v 8	9	W X Y Z w x y z 9
*	. , ' ? ! " - () @ / : _ ; + % * = < > \$ [] { } \ ~ ^ # ` &	0	Space	#	Switch mode

- **“ABC” Mode:**

This mode allows to enter capital letters, digits and symbolic characters.

Following table describes allowed characters for each key.

Key	Description	Key	Description	Key	Description
1	. , ' ? ! " - 1	2	A B C 2	3	D E F 3
4	G H I 4	5	J K L 5	6	M N O 6
7	P Q R S 7	8	T U V 8	9	W X Y Z 9
*	. , ' ? ! " - () @ / : _ ; + % * = < > \$ [] { } \ ~ ^ # ` &	0	Space	#	Switch mode

- **“abc” Mode:**

This mode allows to enter small letters, digits and symbolic characters.

Following table describes allowed characters for each key.

Key	Description	Key	Description	Key	Description
1	. , ' ? ! " - 1	2	a b c 2	3	d e f 3
4	g h i 4	5	j k l 5	6	m n o 6
7	p q r s 7	8	t u v 8	9	w x y z 9
*	. , ' ? ! " - () @ / : _ ; + % * = < > \$ [] { } \ ~ ^ # ` &	0	Space	#	Switch mode

- **“123” Mode:** This mode allows to enter digits and . only.

Following table describes allowed characters for each key.

Key	Description	Key	Description	Key	Description
1	1	2	2	3	3
4	4	5	5	6	6
7	7	8	8	9	9
*	.	0	0	#	Switch mode

Tips using the keypad:

- To switch between the modes, users could press the middle softkey or # key.



- Press multiple times on same key to move forward between the allowed characters.
- Use Right/Left arrow keys to change the cursor's position on the text entered.



WP820 WEB GUI ACCESS CONFIGURATION

The WP820 can be configured using:

- Web GUI embedded on the WP820 using PC's web browser.
- LCD Configuration Menu using the WP820 keypad.

Note: From the Web GUI, you can configure all the functions supported by the WP820; while via keypad menu, you can access limited configuration.

Configuration via Web Browser

The WP820 embedded Web server responds to HTTP/HTTPS GET/POST requests. Embedded HTML pages allow a user to configure the WP820 through a Web browser such as Google Chrome, Mozilla Firefox.

Note: Please note that Microsoft's IE 9 and below are not supported, also the records from the web can't be played with IE10, Edge and Safari. We highly recommend using Google Chrome or Mozilla Firefox.

Accessing the Web UI

1. Connect the computer to the same network as WP820.
2. Make sure the WP820 is booted up and powered correctly.
3. You may check WP820 IP address via a subscribed WP820 on its LCD menu **Settings** → **Network Status**. Please see [WP820 Network]
4. Open Web browser on your computer and enter the WP820 IP address in the address bar of the browser.
5. Enter the administrator's username and password to access the Web Configuration Menu.

Notes:

- The computer must be connected to the same sub-network as the WP820. This can be easily done by connecting the computer to the same hub or switch as the WP820.
- The default administrator username and password are "admin"; the default end-user username is "user" and the password is "123".
- If '**Disable web UI access**' parameter is enabled under **Advanced settings** → **System security**; web UI access will be disabled.



Web GUI Languages

Currently the WP820 web GUI supports English, Chinese languages.

Users can select the displayed language in web GUI login page, or at the upper right of the web GUI after logging in

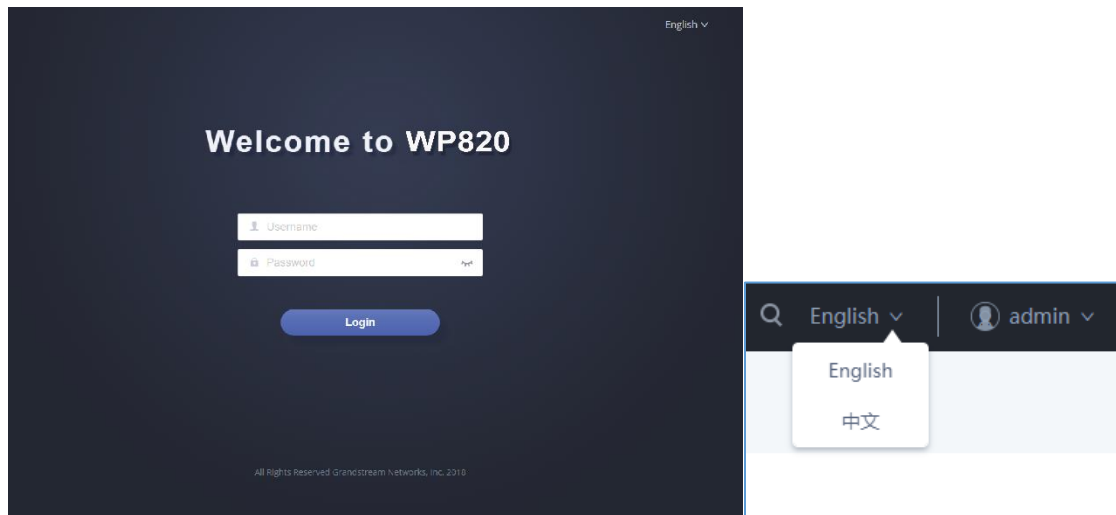

Figure 6: WP820 Web GUI Language

Saving the Configuration Changes

When changing any settings, always submit them by pressing **Save** and **Apply** buttons. If using the **Save** button, after making all the changes, click on the **Apply** button on top of the page to submit.

Web UI Access Level Management

There are two default passwords for the login page:

User Level	Username	Password	Web Pages Allowed
End User Level	user	123	Only Status, Phone Settings, System Settings, Maintenance and System Application with limited options.
Administrator Level	admin	admin	All pages

Changing User Level Password

1. Access the Web GUI of your WP820 using the admin's username and password. (Default username and password are: admin/admin).
2. Press **Login** to access your settings.
3. Go to **System Settings** → **Security Settings**.



4. In **User Info Management**, locate **user password** section:
 - a. Type in the admin password in the **Current Admin Password** field.
 - b. Type in your new user password in **New User Password** field.
 - c. Type in again same entered password in **Confirm New User Password** field.
5. Press **Save** and **Apply** buttons to save your new settings.

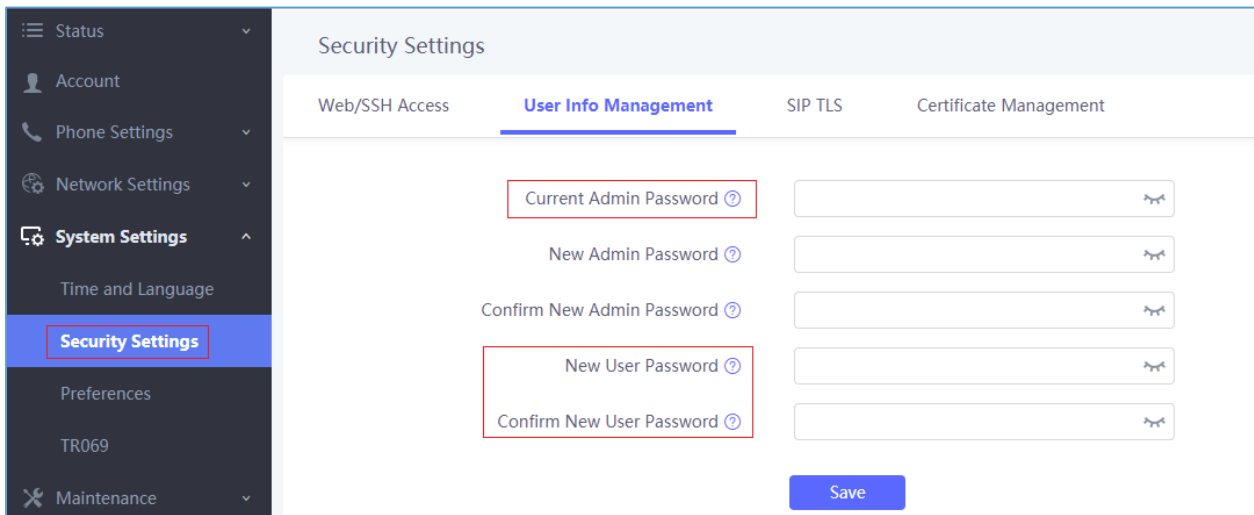

Figure 7: User Level Password

Notes:

- DO NOT USE same password for both user and admin accounts.
- The password is case sensitive with maximum length of 25 characters.

Changing Admin Level Password

1. Access the Web GUI of your WP820 using the admin's username and password. (Default username and password is: admin/admin).
2. Press **Login** to access your settings.
3. Go to **System Settings** → **Security Settings**.
4. In **User Info Management**, locate **admin password** section:
 - a. Type in the admin password in the **Current Admin Password** field
 - b. Type in your new user password in **New Admin Password** field.
 - c. Type in again same entered password in **Confirm New Admin Password** field.
5. Press **Save** and **Apply** buttons to save your new settings.



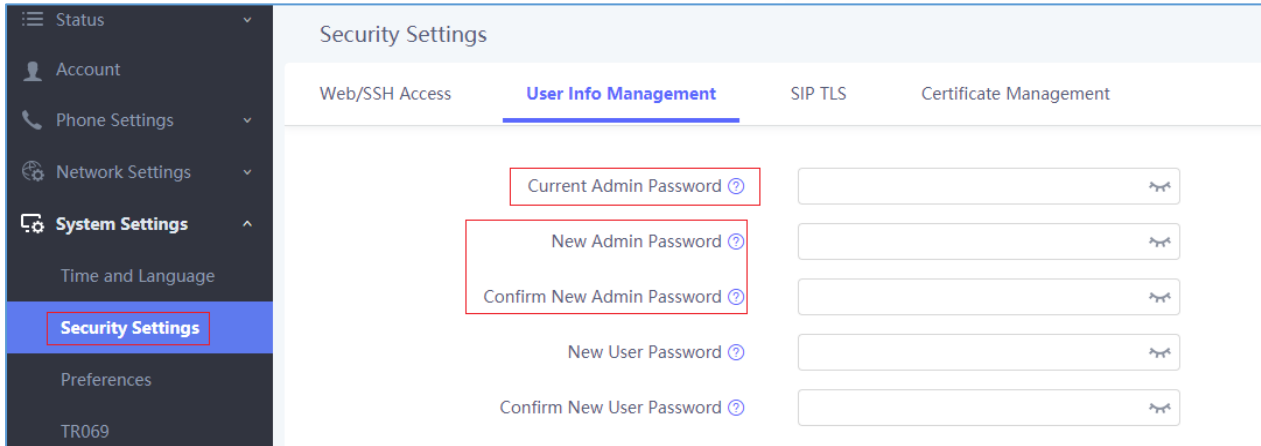

Figure 8: Admin Level Password

Notes:

- DO NOT USE same password for both user and admin accounts.
- The password is case sensitive with maximum length of 25 characters.

Changing HTTP / HTTPS Web Access Port

1. Access the Web GUI of your WP820 using the admin's username and password. (Default username and password are: admin/admin).
2. Press **Login** to access your settings.
3. Go to **System Settings** → **Security Settings**.
4. In **Web/SSH Access** page, select the access method depending on desired protocol (HTTP or HTTPS)
5. Locate **HTTP / HTTPS Web Port** field and change it to your desired/new HTTP / HTTPS port.
Note: By default, the HTTP port is 80 and HTTPS is 443.
6. Press **Save** and **Apply** buttons to save your new settings.

Note: After modifying the connection method or port, the web GUI will be automatically logged out and redirected to the new address

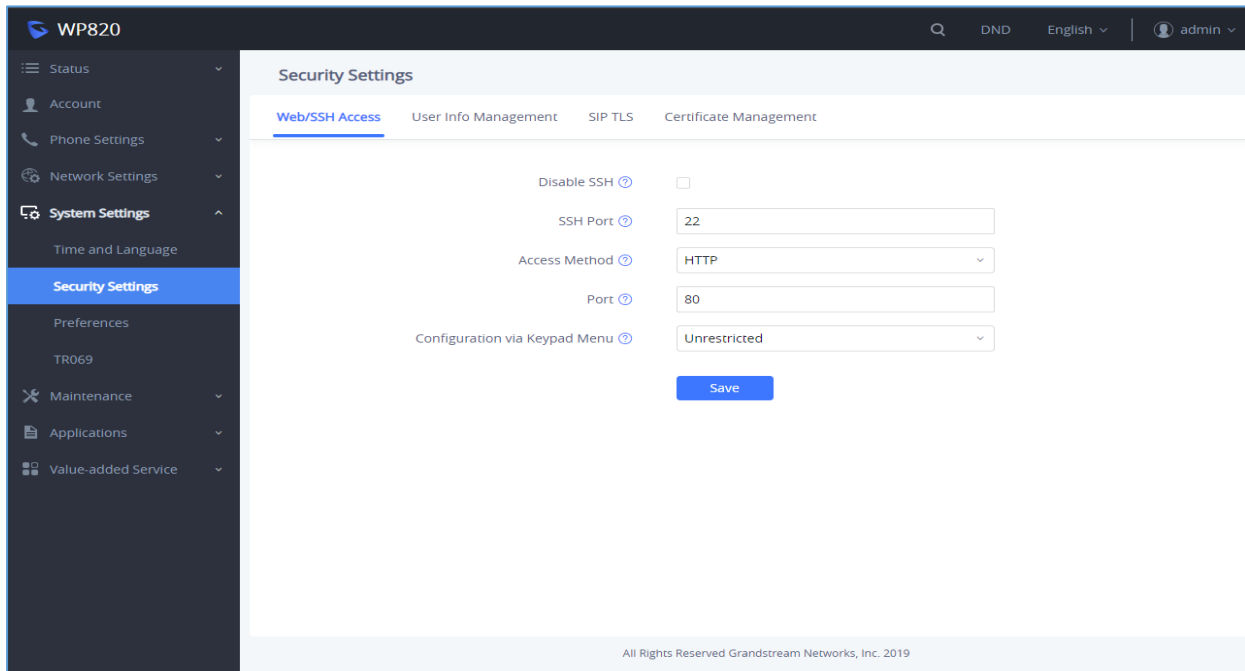

Figure 9: Web/SSH access

BASIC OPERATIONS

WP820 Home Screen

The WP820 Home screen comprises three pages that make it easy for the customer to access some settings, parameters or notifications. *Please refer to the following screenshots:*

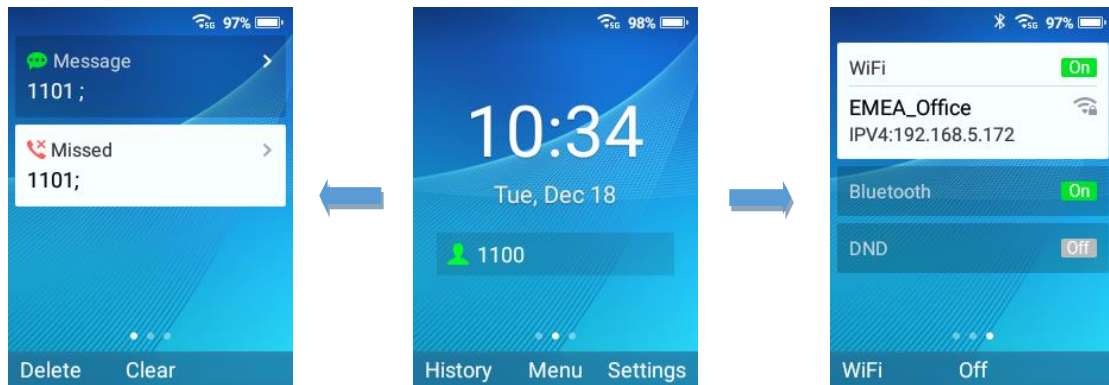

Figure 10: Home screen pages

Left Home Screen Page:

- This page lists all the notifications that users need to check: Missed calls, unread SMS, unread Voice mails, etc ...
- Users can access the notification by tapping on OK button, delete the notification by tapping on the left softkey or clear all the notifications by tapping on the middle softkey.

Middle Home Screen Page:

- The middle page of Home screen shows date/time and the registered SIP account(s) on the WP820.
- Users can access by default to History, Menu or Setting by using softkeys, and Administrator is able to change the functions of softkeys on Home screen from the Web GUI.

Right Home Screen Page:

- The right page is providing the users quick access to Wi-Fi, Bluetooth and DND option and configuration.
- Users can turn on/off the option using the middle softkey, while they also can access to the settings of each option by tapping on the left softkey.

Turning the Handset ON/OFF

To turn ON the handset: Long  press on **Power key** until the LCD screen lights up.

To turn OFF the handset: Long  press on **Power key** again when the handset is idle and press the softkey to choose to power off or reboot.

Connecting WP820 to Wi-Fi Network

Auto Connection

For easy deployment, WP820 out of the box is preconfigured to connect to a default SSID named **wp_master** with a password (WPA/WPA2 PSK) equal to **wp!987@dmn**, users can adapt these settings from the web UI as well to make it easier for deployment on customer site.

Go under the web interface of the “**Network Settings → Wi-Fi Settings → Wi-Fi Security**”.

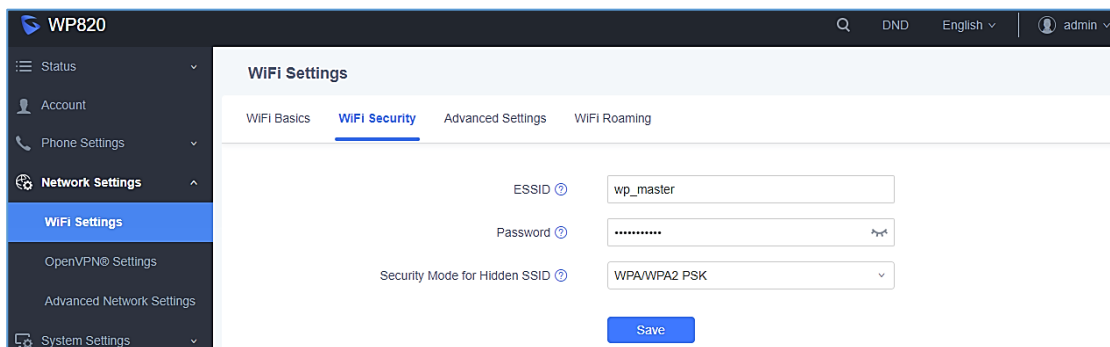

Figure 11: Default Wi-Fi Network

For example, the user can pre-configure the WP to automatically connect to the Wi-Fi network at the client site, making it easier for the client to use the phone without going through the setting up manually the Wi-Fi network. Also, the client could have the SSID hidden by default, and the WP820 handset would still be able to connect to the Wi-Fi network since they have SSID and password information configured.

Manual connection

The WP820 supports dual-band 802.11a/b/g/n Wi-Fi, please refer to the following steps in order to connect your WP820 to the Wi-Fi networks:

1. On LCD menu, press Menu key and navigate to **Settings → Network Settings → Wi-Fi**.
2. Set Wi-Fi to “On”, and navigate to “Wi-Fi Settings”. A list of Wi-Fi networks will be displayed.
3. Select the desired network to connect to. (Enter the correct password to connect if requested)

WP820 will display Wi-Fi icon on the main LCD menu if the connection to the Wi-Fi network is successful.



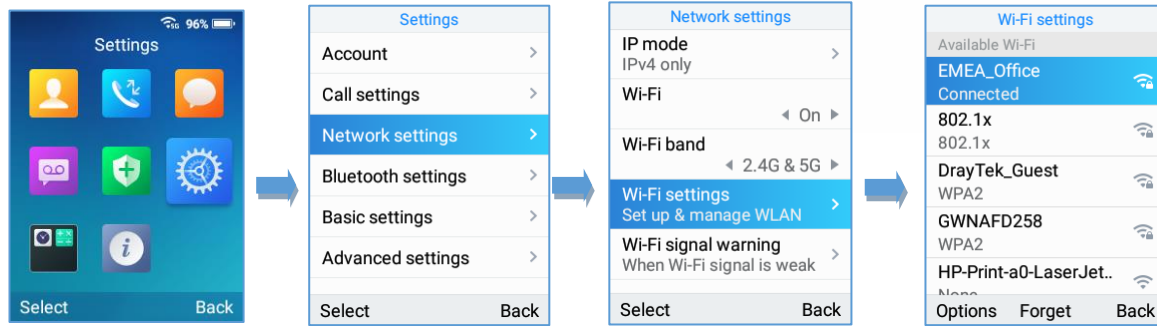

Figure 12: Connecting WP820 to Wi-Fi Network

Note: WP820 supports connection to Wi-Fi with captive portal enabled that requires additional credentials to sign up or login before it's allowed to use Wi-Fi.

Wi-Fi Band Configuration

If 5GHz and 2.4GHz are both available, the WP820 will use 5GHz, but it may switch to 2.4GHz if the signal of 5GHz is poor. Users may also specify the Wi-Fi Band in order to fix it or to keep it Dual Band under **Settings→Network Settings→Wi-Fi Band**.

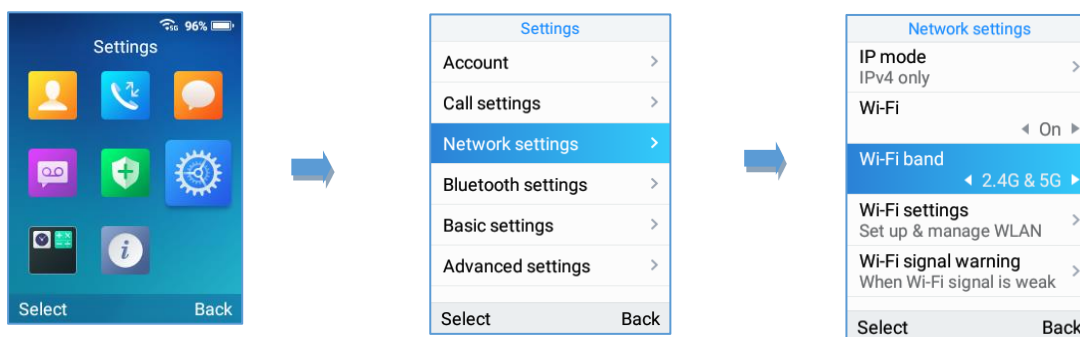

Figure 13: Wi-Fi Band configuration

Note: Wi-Fi will restart after changing WI-FI frequency.

Wi-Fi Signal Warning Configuration

Users Can configure Wi-Fi signal warning sensitivity or disable it under **Settings→Network Settings→Wi-Fi signal warning**. Five sensitivity levels are available: Level 1 is the lowest and level 5 is the highest.

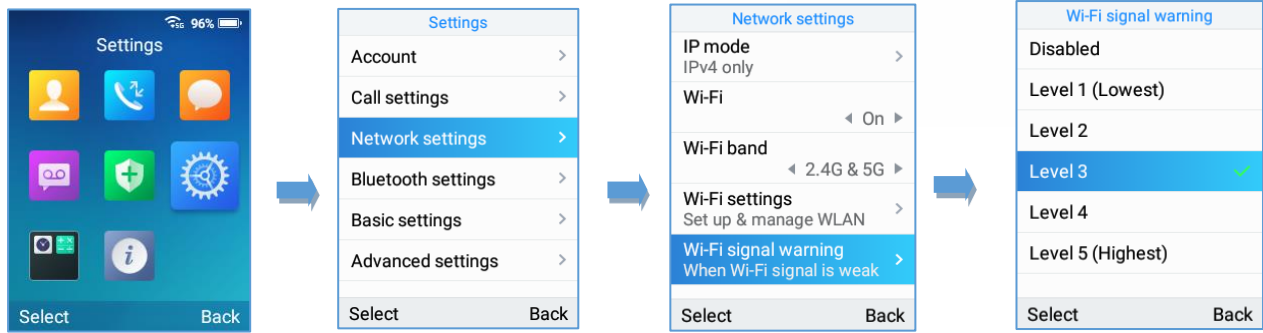

Figure 14: Wi-Fi Signal Warning Sensitivity

Note: A message prompt also appears to notify users about poor Wi-Fi signal. While during the call, a beep tone will be played to notify users that Wi-Fi connection is lost.

Wi-Fi Roaming Mode Configuration

Wi-Fi Roaming settings configuration can also be done by users under **Settings**→**Network Settings**→**Wi-Fi Roaming Mode**.

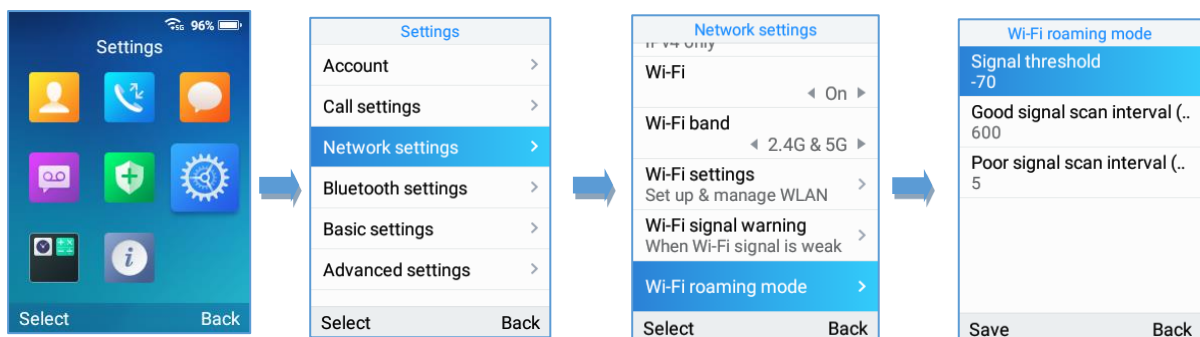

Figure 15: Wi-Fi Roaming Mode

The options that can be configured under “Wi-Fi Roaming Mode” are the following:

- **Signal Threshold:** When the Wi-Fi signal strength of the device drops below this value, the device will scan for a hotspot above the threshold value and connect to it. The default setting is -70.
- **Good Signal Scan Interval:** The time interval for signal scanning when the Wi-Fi signal strength is higher than the signal threshold. The default setting is 600s.
- **Poor Signal Scan Interval:** The time interval for signal scanning when the Wi-Fi signal strength is lower than the signal threshold and there is no hotspot which is higher than the current signal strength. The default setting is 5s.



Connecting WP820 to Bluetooth Devices

Bluetooth is a proprietary, open wireless technology standard for exchanging data over short distances from fixed and mobile devices, creating personal area networks with high levels of security. The WP820 supports Bluetooth version 4.2.

To connect to a Bluetooth device, turn on the WP820's Bluetooth radio first. The first time when using a new Bluetooth device with the WP820, "pair" the device with WP820 so that both devices know how to connect securely to each other. After that, users could simply connect to a paired device. Turn off Bluetooth if it's not used.

Bluetooth settings are under WP820's **Settings**→**Network Settings**→**Bluetooth Settings**.

Turn On/Off Bluetooth

1. Go to WP820's **Settings**→**Network Settings**→**Bluetooth**.
2. Turn On or Off the Bluetooth option.

Change Bluetooth Device Name

The WP820 uses "WP820_XXXXXX" as Bluetooth device name by default where "XXXXXX" are the last 6 digits of the phone's Bluetooth MAC address plus 1. The device name will be visible to other devices when connecting them. Follow the steps below to change the name:

1. Go to WP820's **Settings**→**Network Settings**→**Bluetooth**
2. Turn on **Bluetooth**.
3. Go to WP820's **Settings**→**Network Settings**→**Bluetooth Settings**.
4. Press "Device name".
5. Enter a name and tap on "Save"

Pair WP820 with a Bluetooth Device

Before connecting the WP820 with other Bluetooth device, users must pair them first. They will stay paired afterwards unless they are unpaired.

1. Go to WP820's **Settings**→**Network Settings**→**Bluetooth**.
2. Turn on **Bluetooth**.
3. Go to WP820's **Settings**→**Network Settings**→**Bluetooth Settings** and set "**Visible to nearby Bluetooth devices**" to **ON** and set the **Visibility timeout** settings to make the WP820 phone visible to all nearby Bluetooth devices.



4. Set the **Bluetooth headset mode** parameter to ON in order to allow the WP820 to pair with other Bluetooth mobile devices to make calls. After successful pairing, users can press the call key and then press “Accounts” to select the Bluetooth account.

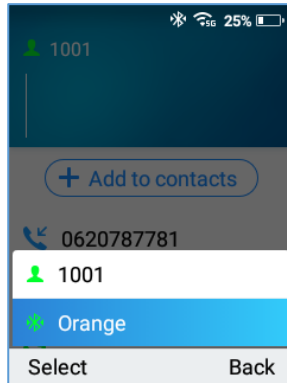

Figure 16: Make calls using Bluetooth account

5. Access the **Bluetooth devices settings** and press on **Refresh** softkey, the WP820 will scan and display the IDs of all available Bluetooth devices in range. If the device you would like to pair with does not show up in the list (available devices), ensure that the other device is turned on and set to be discoverable.

Once the Bluetooth device shows up in the result, press on it and specify if you want to allow it to access your contacts and call history then press on **Pair**. Confirm the passkey in the prompted message (if any).

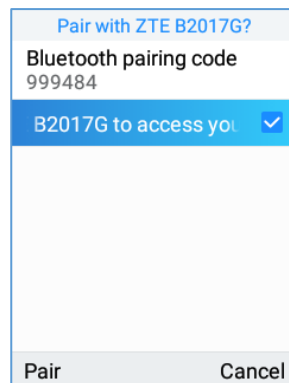

Figure 17: Pair WP820 to a Bluetooth Device

Unpair a Bluetooth Device

1. In the **Bluetooth devices** settings → **Paired devices**, select and press on the already paired Bluetooth device name you want to unpair.
2. Press on **Unpair**.



Connect to a Bluetooth Device

1. In the **Bluetooth devices** settings → **Paired devices**, select the paired device you want to connect to.
2. Press on **Connect**.

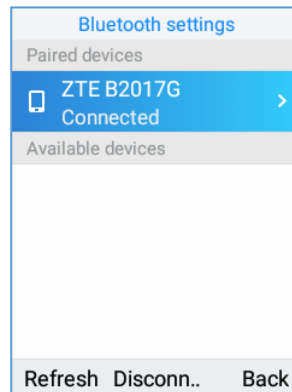

Figure 19: Connect to a Bluetooth device

The Bluetooth connected device's name will be showing in the Bluetooth devices menu.

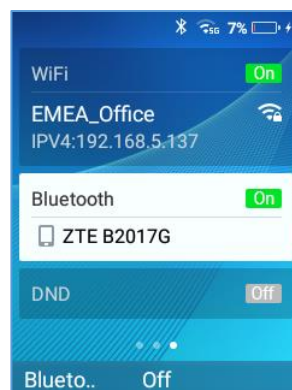

Figure 18: Bluetooth profile

Connect to a Bluetooth Device from Web Interface

Turn On/Off Bluetooth

1. Go to WP820's GUI → **Network Settings** → **Bluetooth**.
2. Turn On or Off the Bluetooth option.

Change Bluetooth Device Name

The WP820 uses "WP820_XXXXXX" as Bluetooth device name by default where "XXXXXX" are the last 6 digits of the phone's Bluetooth MAC address plus 1. The device name will be visible to other devices when connecting them. Follow the steps below to change the name:

1. Go to WP820's GUI → **Network Settings** → **Bluetooth**
2. Change the "Device name" then click on "Save".

Pair WP820 with a Bluetooth Device

Before connecting the WP820 with other Bluetooth device, users must pair them first. They will stay paired afterwards unless they are unpaired.

1. Go to WP820's GUI → **Network Settings** → **Bluetooth**.
2. Turn on **Bluetooth**.
3. Enable “Bluetooth Headset Mode” and press Scan.
4. Select device from the discovered list and then click “save” then “**Pair**” and enter the key PIN on the paired device.

Checking WP820 Status

WP820 Account Status

To check the SIP accounts status, follow these steps:

1. Press **Menu** key to bring up operation menu.
2. Use arrow keys to Reach **Status** menu and navigate to **Account status**.

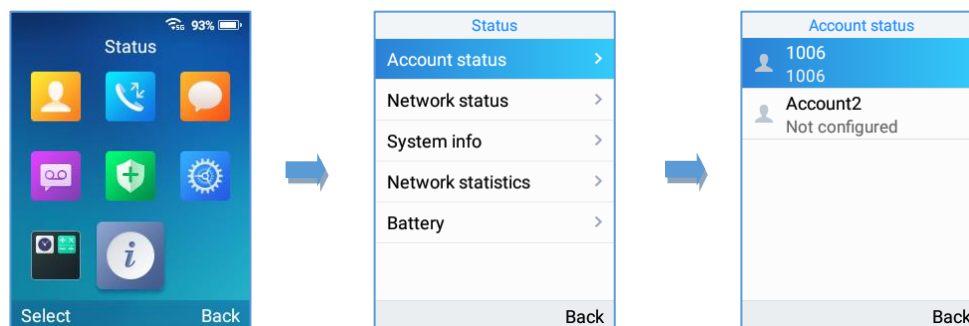

Figure 20: WP820 Account Status

The following information will be displayed:

Table 7: WP820 Account Status Description

Item	Description
Account 1	Displays the information about the first account including name, number and the status of its registration.
Account 2	Displays the information about the second account including name, number and the status of its registration.

WP820 Network Status

To check the handset network information status, follow these steps:

1. Press **Menu** key to bring up operation menu.
2. Use arrow keys to reach **Status** menu and navigate to **Network Status**.

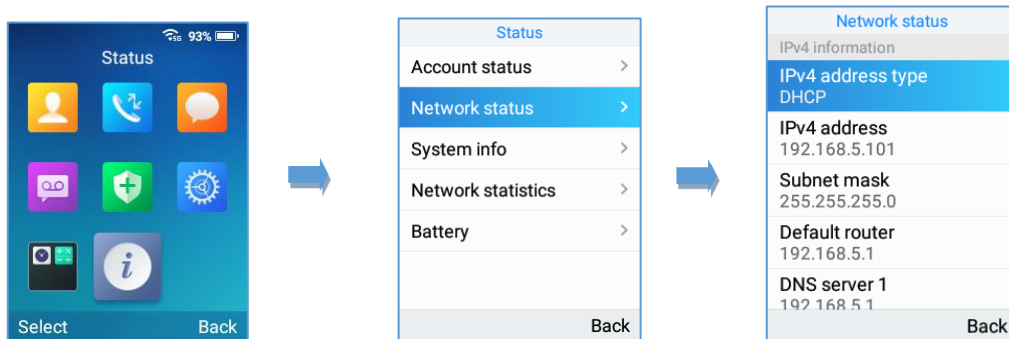

Figure 21: WP820 Network Status

Table 8: WP820 Network Status Description

Item	Description
IPv4 information	
IPv4 Address Type	Displays the IPv4 address type.
IPv4 Address	Displays the IPv4 address.
Subnet mask	Displays the subnet mask address.
Default router	Displays the IPv4 address of the router.
DNS Server 1	Displays the IPv4 address of the primary DNS Server.
DNS Server 2	Displays the IPv4 address of the secondary DNS Server.
IPv6 information	
IPv6 Address Type	Displays the IPv6 address type.
IPv6 Address	Displays the IPv6 address.
DNS Server 1	Displays the IPv6 address of the primary DNS Server.
DNS Server 1	Displays the IPv6 address of the secondary DNS Server.

Other network information	
MAC address	Displays the handset's MAC address.
NAT Type	Displays the NAT type.
VPN	
VPN address	Displays the VPN IPv4 address.

WP820 System Info

To check the system info, follow these steps:

1. Press **Menu** key to bring up operation menu
2. Use arrow keys to reach **Status** menu and navigate to **System Info** section.

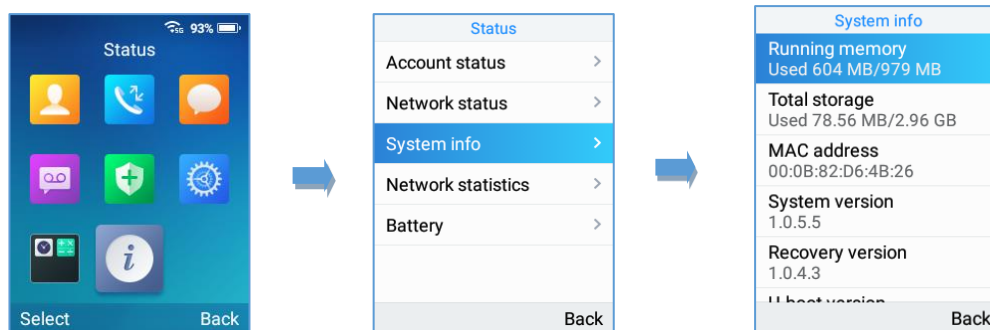

Figure 22: System Info

The following information will be displayed:

Table 9: WP820 System Info Description

Item	Description
Running Memory	Displays information about the memory.
Total Storage	Displays information about the storage space on the phone.
MAC Address	Displays the MAC Address of the phone.
System Version	Displays the current firmware version installed.
Recovery Version	Displays the recovery version installed.
U-boot Version	Displays the u-boot version installed.
Kernel Version	Displays the kernel version installed.

Hardware Version	Displays the hardware version.
LCD_SN	Displays the LCD serial number.
DDR_SN	Displays the DDR serial number.
FCT_SN	Displays the FCT serial number.
SN	Displays the unit's serial number.
PN Number	Displays the Part Number.
Country code	Displays the country code.
Running Time	Displays the time during which the WP820 is powered on and working.

WP820 Network Statistics

To check the handset network information status, follow these steps:

1. Press **Menu** key to bring up operation menu.
2. Use arrow keys to reach **Status** menu and navigate to **Network Statistics**.

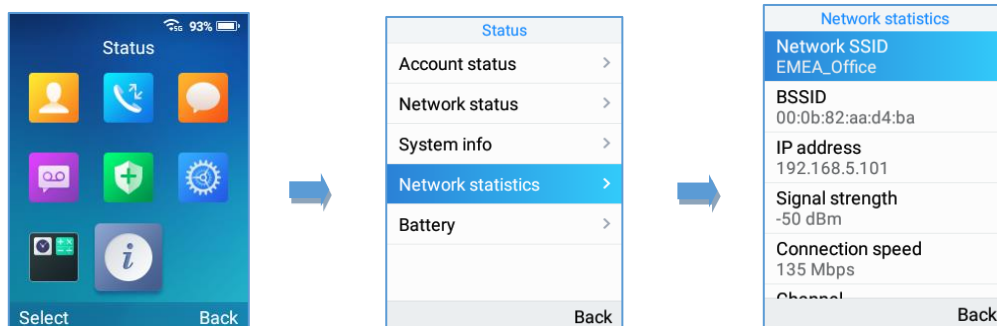

Figure 23: WP820 Network Status

The following information will be displayed:

Table 10: WP820 Network Status Description

Item	Description
Network SSID	Displays the SSID Name on which the handset is connected.
BSSID	Displays the MAC address of the Access Point on which the handset is connected.
IP Address	Displays the IP address of the handset.
Signal strength	Displays the Wi-Fi signal strength.
Connection Speed	Displays the connection speed value.

Channel	Displays the channel on which handset is placed.
Frequency	Displays the channel frequency.
TX Packets	Displays the total packets volume sent by handset.
TX error packets	Displays the amount of packets that failed to be transmitted.
TX error rate	Displays the global percentage of packets that failed to be transmitted.
TX drop packets	Displays the amount of TX packets that were dropped by router.
TX drop rate	Displays the global percentage of TX packets that were dropped by router.
RX Packets	Displays the total packets volume received by handset.
RX error packets	Displays the amount of packets that failed to be received.

WP820 Battery

To check the Battery information, follow these steps:

1. Press **Menu** key to bring up operation menu.
2. Use arrow keys to Reach **Status** menu and navigate to **Battery**.

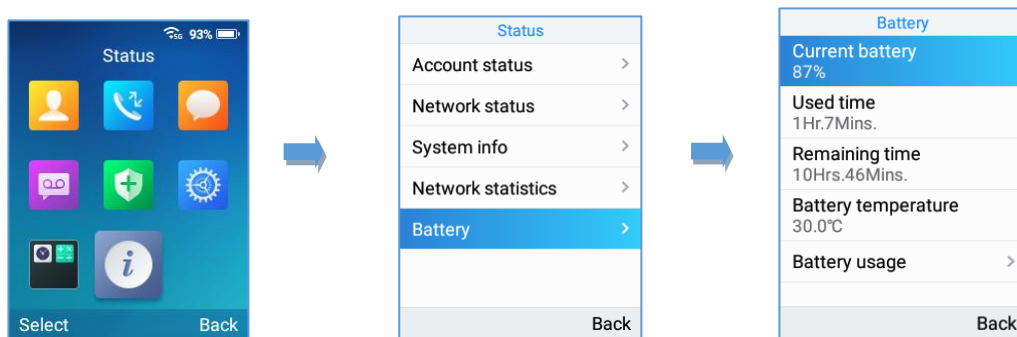

Figure 24: WP820 Battery

The following information will be displayed:

Table 11: WP820 Battery Description

Item	Description
Current Battery	Displays the current Battery percentage.
Used Time	Displays the handset used time on Battery since the last full charge.
Remaining time	Displays the remaining battery time.
Battery Temperature	Displays the current Battery temperature.

Battery usage

Displays the percentage of battery consumption of each app.

Screen Lock

Setting the Key Lock from Handset

To configure Key lock from the handset, follow below steps:

1. Access WP820's menu → Settings → Basic Settings → Display → Lock Screen.
2. Set "Lock screen" to "On".
3. (Optional). Configure "Set Password" to define a PIN code (6-digit numerical password) to unlock the keypad and press "Save".

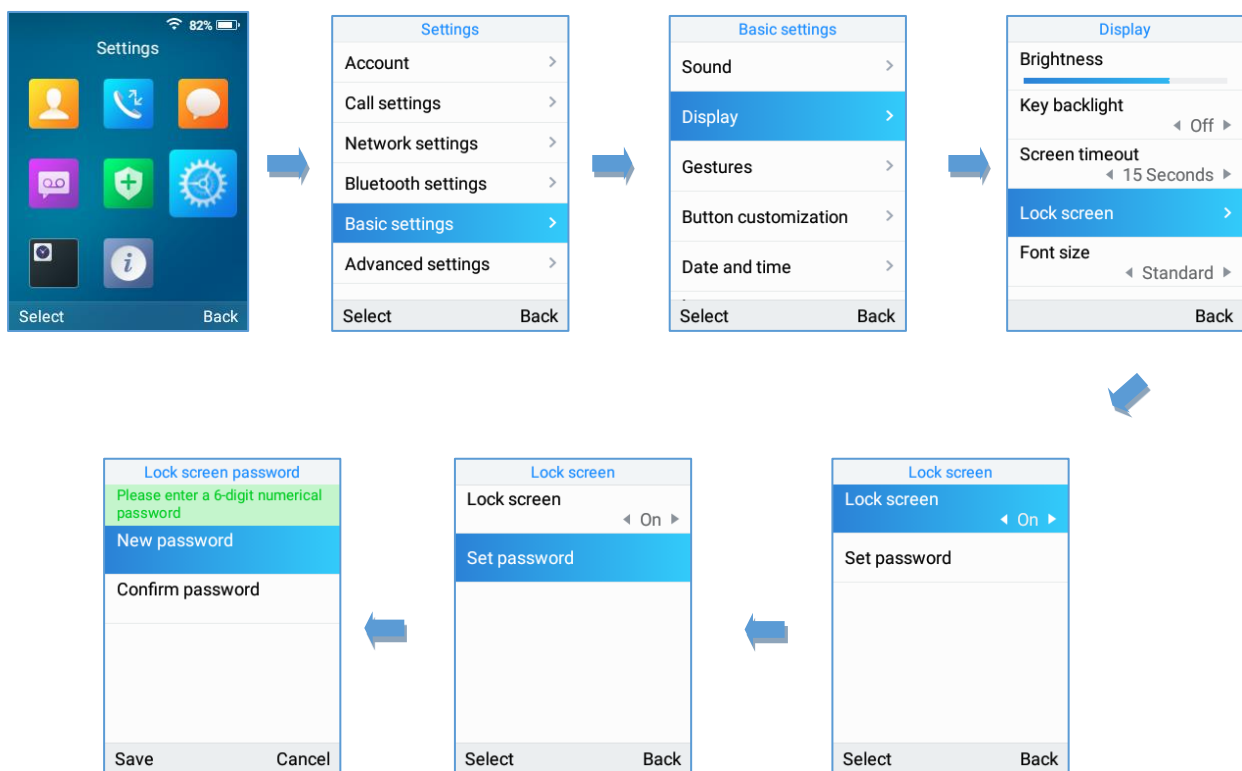

Figure 25: Keypad lock from handset

Lock Screen Settings from Web GUI

User can configure lock screen functions on the web UI. The screen lock password was also added to provide additional security. Default Disabled.

1. Proceed from System Settings → Security Settings → Lock Screen Settings.
2. Enable option "Screen Lock Function".



- On Screen Lock Password, click on Add Password then once done, click OK then Save then Apply.

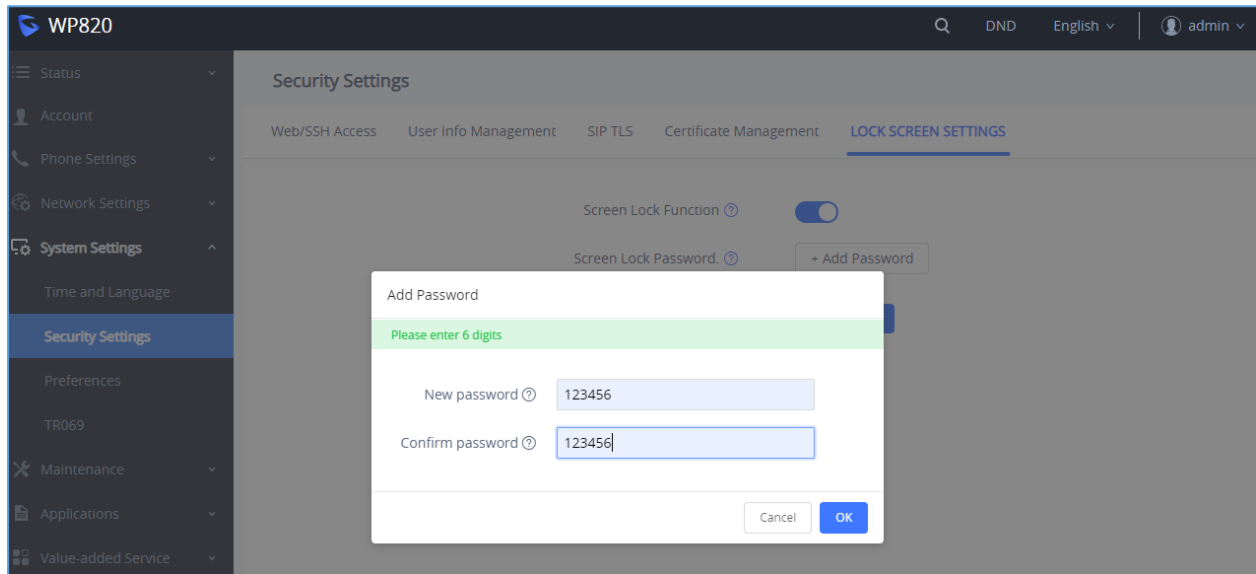

Figure 26: Lock Screen Settings

Locking/Unlocking the Screen

• To lock the Screen

- Press the **Pound key “#”** and hold for approximately 2 seconds, or
- Press **On-hook / power key** while the LCD is idle.

• To unlock the Screen

- Press **Unlock** button (Left softkey) and **Pound key “#”** to unlock the keys.



Figure 27: Unlock Keypad

Note: When the phone is locked, it is still possible to pick up incoming calls.

Configuring the LCD Brightness and Screen Timeout

1. Press **Menu** to bring up operation menu.
2. Use arrow keys to reach **Settings**.
3. Navigate to **Basic Settings**, and then select **Display**.
4. Configures the LCD brightness, key backlight, lock screen, screen time out and the font size.
5. Press “**Back**” (right softkey) to save and apply the new settings.

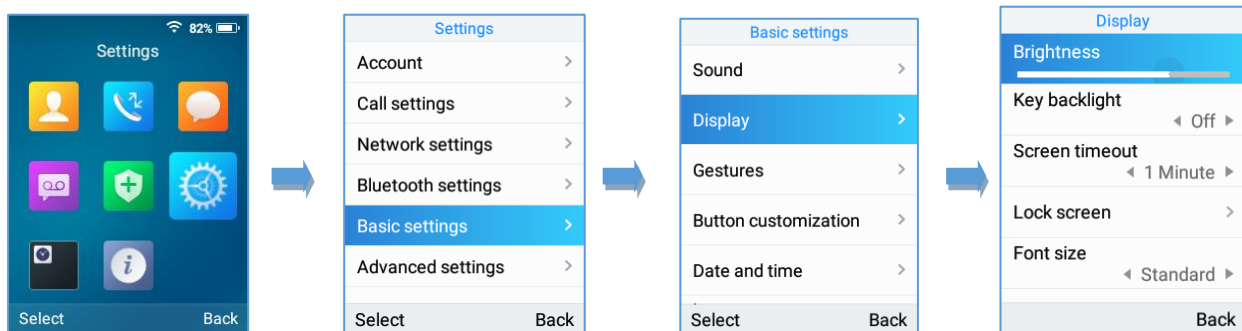



Figure 28: LCD Display Configuration

Return to Idle Screen

Press the **Power Key**  to quickly exit the menu and return back to the main idle screen.

When you are navigating on the handset's menu, and you receive an incoming call, the LCD screen will automatically exit the menu and you can either accept or reject the call, when the call is terminated, the LCD screen will return back to the idle screen.

Register a SIP Account

The WP820 supports up to 2 SIP accounts and they can be configured either using the web GUI or via the keypad menu as described on the following section.

Register Account via Web User Interface

1. Access your WP820 base station web UI by entering its IP address in your favorite browser.
2. Enter your admin's username and password (default username and password: admin/admin).
3. Press **Login** to access your settings.
4. Go to **Account** tab and select the account to configure.



5. In **General Settings**, set the following:
 - a. **Account Active** to **Yes**.
 - b. **Account Name**: Any name to identify this specific user.
 - c. **SIP Server** field with your SIP server IP address or FQDN.
 - d. **Secondary SIP Server** with your secondary SIP server IP address or FQDN. Leave empty if not available.
 - e. **SIP User ID**: User account information, provided by VoIP service provider (ITSP). Usually in the form of digit similar to phone number or actually a phone number.
 - f. **SIP Authenticate ID**: SIP service subscriber’s authenticate ID used for authentication. Can be identical to or different from SIP User ID.
 - g. **SIP Authentication Password**: SIP service subscriber’s account password to register to SIP server of ITSP. For security reasons, the password will field will be shown as empty.
 - h. **Outbound Proxy**: configure this field with your outbound proxy IP address or FQDN. Leave empty if not available.

6. Press **Save and Apply** to save your configuration.

After applying your configuration, your phone will register to your SIP Server. You can verify if your WP820 has registered with your SIP server from its web interface under **Status** → **Account Status** (“**Registered**” with green color when the account is correctly registered, or “**Unregistered**” with grey when the account is not properly registered)

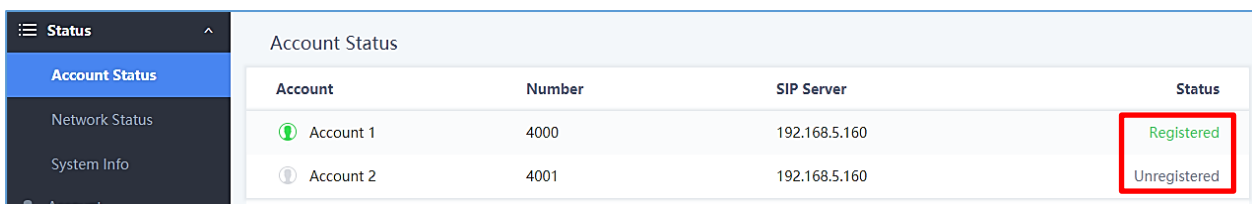

Account	Number	SIP Server	Status
Account 1	4000	192.168.5.160	Registered
Account 2	4001	192.168.5.160	Unregistered

Figure 29: Account Status

Register Account via LCD Menu

To register your SIP account via the LCD menu, please refer to following steps:

1. Unlock your WP820 and press **Menu** to bring up operation menu.
2. Use arrow keys to reach **Settings** and then select **Account** tab.
3. Select which account you want configure and then set the following:
 - a. **Account Activation** to “On”.



- b. **Account Name:** Any name to identify this specific user.
- c. **SIP Server** field with your SIP server IP address or FQDN.
- d. **SIP User ID:** User account information, provided by VoIP service provider (ITSP). Usually in the form of digit similar to phone number or actually a phone number.
- e. **SIP Authenticate ID:** SIP service subscriber's authenticate ID used for authentication. Can be identical to or different from SIP User ID.
- f. **SIP Authentication Password:** SIP service subscriber's account password to register to SIP server of ITSP. For security reasons, the password will field will be shown as empty.
- g. **Outbound Proxy:** configure this with outbound proxy IP address or FQDN. Leave empty if not available.
- h. **Voicemail Access Number:** The voicemail number of your account.
- i. **Display Name:** The name that will be used for caller ID name in SIP INVITE.

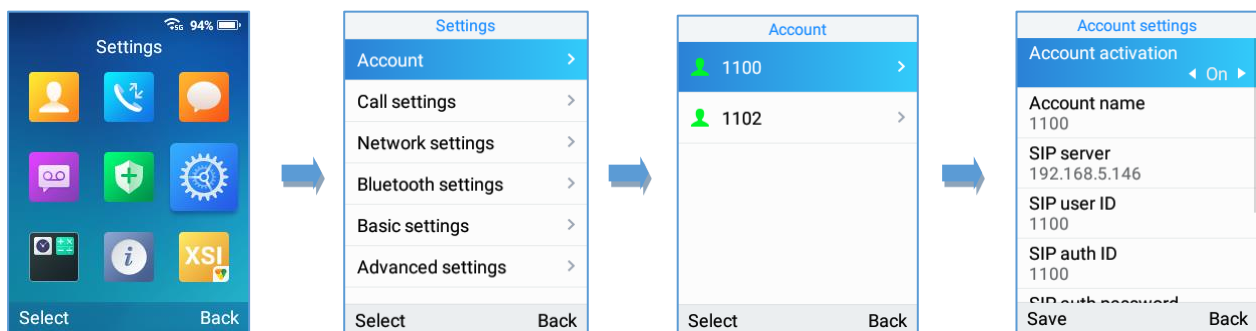

Figure 30: SIP Accounts Configuration

Guest Login

The Guest Login feature provides the ability to share the same wireless phone by multiple users at different periods of time.

Configuration

This feature can be enabled from the WEB GUI under **Phone Settings → General Settings → Guest Features**.



General Settings

Basic Settings
Guest Features

Guest Settings

Guest Login ? i

Guest Login PIN Code ?

Save

SIP Domain

Server Alias ?

Server List ? +

Add
Cancel

Figure 31: Guest Login settings

1. Enable the Guest login by checking the Guest Login parameter.
2. Enter the PIN to be used for authentication.
3. Configure the SIP domain to be used as SIP server for registration:
 - a. Server Alias: The server alias is used to customize the server name.
 - b. The Server list will contain the IP addresses/Domain names to be used as SIP registration servers

Note: A reboot is required for these settings to take effect.

User Login

Once the phone boots up with the Guest Login feature enabled users can follow these steps to login:

1. Press the dial button or press any numeric button.
2. The Guest Login page will be opened, and the user is asked to enter the Extension credentials.
3. Enter the Account ID, the SIP password and choose the Alias of the SIP server configured on the WEB GUI as mentioned on steps above.



4. Set the “Expire parameter” to the number of hours this login will stay valid.

Guest login	
Account name	1003
Password	
SIP domain	◀ Server 1 ▶
Expire	◀ Always ▶
PIN code	
Login	Back

Figure 32: Guest Login Window

Note: When the “Expire” parameter is set to “Always” users are asked to enter the PIN code that was previously configured on the WEB GUI.

User Logout

To logout from the Guest Login mode users can follow these steps:

1. On idle screen, press the **Settings** soft-key.
2. Select **Logout**.
3. Confirm the logout by pressing the **Logout** soft-key.

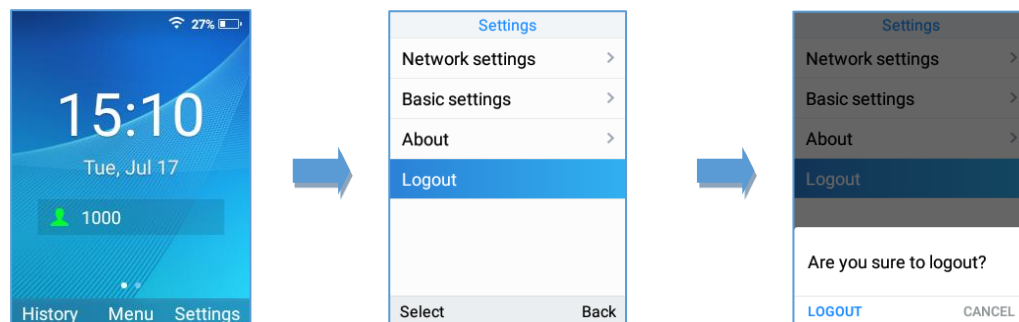

Figure 33: Guest Logout

PHONE SETTINGS

Selecting Phone Language

The WP820 supports different languages. The default language of the handset is English. To change the language of the handset, please proceed as follows:

1. Press **Menu** to bring up operation menu.
2. Use arrow keys to reach **Settings**.
3. Navigate to **Basic Settings**, and then select **Language**.
4. Choose the desired language from the available list and press “**Select**” and then the phone will apply the selected language.

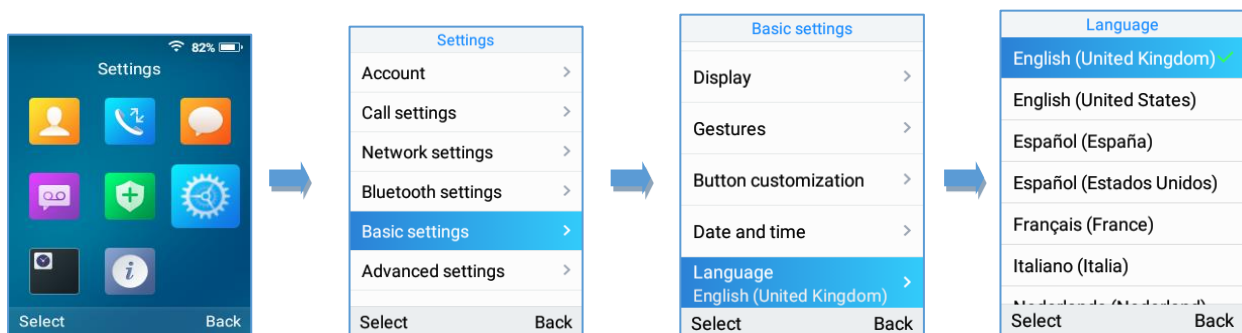



Figure 34: Configuring Phone Language

Activate/Deactivate Hands-Free Mode

- Press the **Hands-free key**  while making a call or on the idle screen to activate hands free mode.
- Press the **Hands-free key**  again to deactivate the hands-free function.

Muting the Microphone

1. Press the button “**Options**” (**Left softkey**) during an established call and a list of the options will be displayed.
2. Choose” **Mute**” and press “**Select**” button (left softkey / OK button) to switch on the microphone.

Notes:

- While muted, the icon  will be displayed on the screen.
- To unmute the microphone during an established call, press the button “**Options**” (**Left softkey**), choose “**Unmute**” and press “**Select**” button (left softkey or OK button) to switch off the microphone.



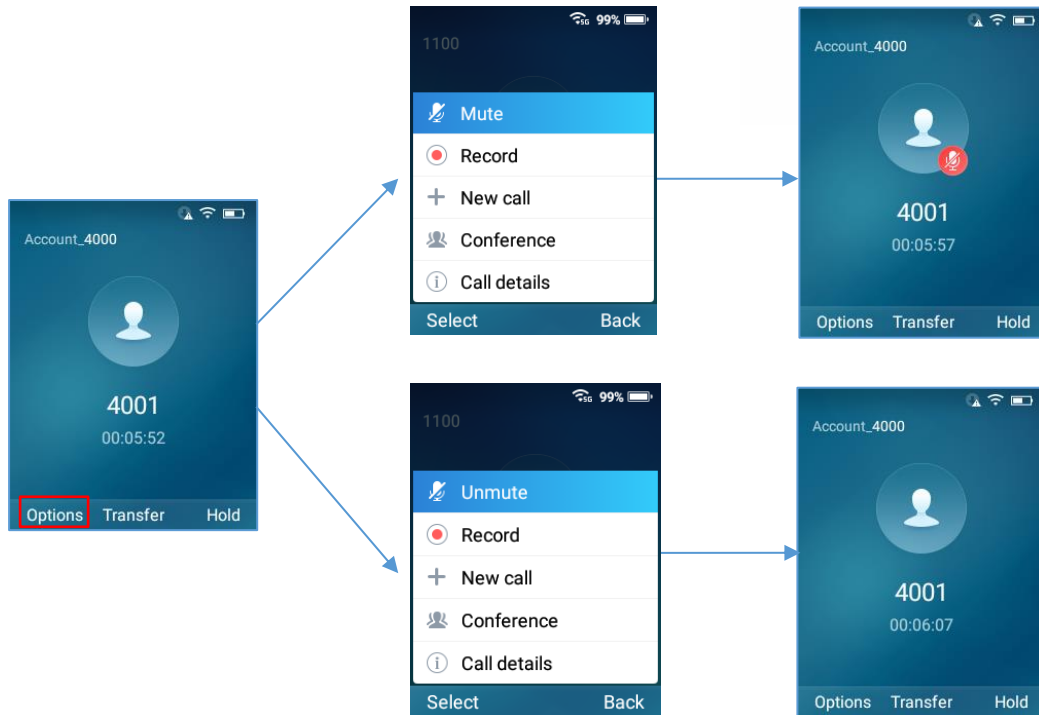

Figure 35: Muting the Microphone

Note: If PTT/Paging button is customized by the administrator to be Mute/Unmute, users can press the Multi-function button to Mute/Un-mute the MIC during calls.

Adjusting Speaker and Earpiece Volume

Press volume up and down keys on the left side of your phone while you are on an established call to set the volume of the earphone / speaker. You can choose between 8 different levels. The default level is 4.

Ringtones

Setting the Ringer Volume on the WP820

To configure the desired ringer volume, proceed as follows:

1. Press **Menu** to bring up operation menu and go to **Settings**.
2. Navigate to **Basic Settings**, and then select **Sound** tab.
3. User can configure the silent and vibrate modes and also the voice ringtones by pressing the left and right arrow keys to change repeatedly and set the desired volume.
4. Press "**Back**" (right softkey) to confirm the new configuration settings.



Notes:

- 15 levels are supported. Level 15 is the highest level. Level 8 is default.
-  appears when silent mode is enabled. In this mode no ring will be played for incoming calls.

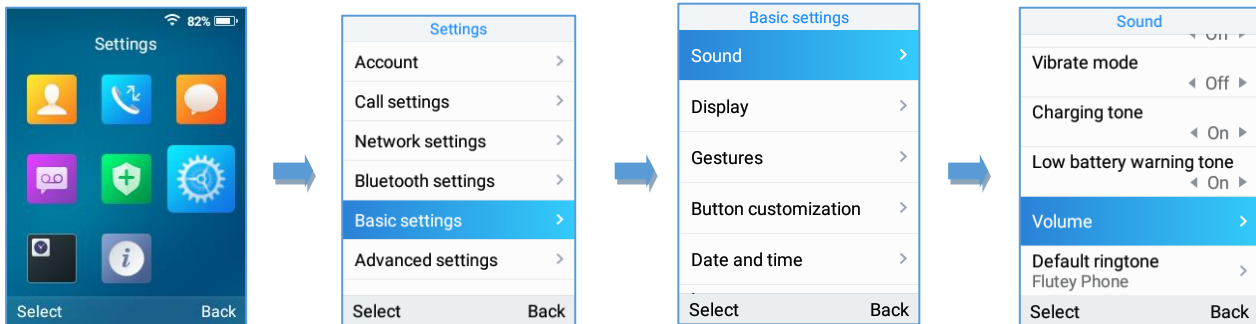

Figure 36: Ringer Volume

Setting the Ringtones on the WP820

You can change the ringer melody for an incoming call. The device has different ringer melodies and in order to configure the desired melody, proceed as follows:

1. Press **Menu** to bring up operation menu.
2. Use arrow keys to reach **Settings → Basic Settings**, and then select **Sound** tab.
3. Go to **“Default Ringtone”**, and choose the desired ringtones, press **“Save”** to confirm the ringtones selected and the new ringtones will be set successfully.

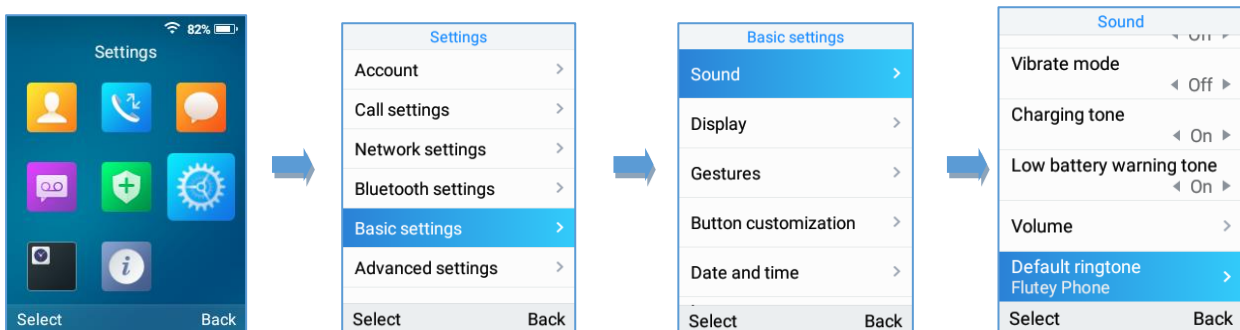

Figure 37: Calls Default Ringtone

Date and Time

On the WP820 the Date and time are displayed on the idle screen and it obtains the date and time from the Simple Network Time Protocol (SNTP) server by default. If your phone cannot obtain the date and time from the SNTP server, you need to configure the date and time manually. You can configure the time format and date format respectively. The handset supports two formats for time (12 Hour or 24 Hour) and three date formats (DD/MM/YYYY; MM/DD/YYYY; YYYY/MM/DD).

To configure date and time manually



1. Press **Menu** to bring up operation menu.
2. Use arrow keys to reach **Settings** → **Basic Settings**, and then select **Date and Time** tab.
3. Press **“Back”** softkey to apply your changes.

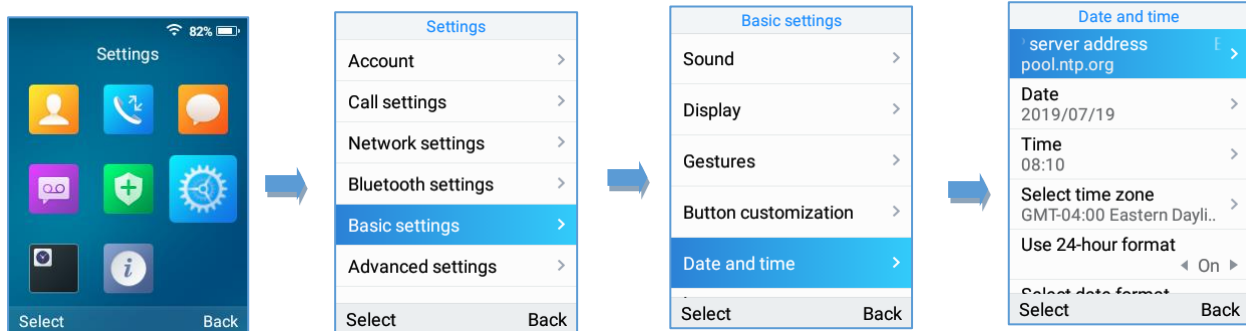

Figure 38: Date and Time Settings

Wallpaper Customization

WP820 wallpaper is customizable through web GUI and the user can upload up to 10 wallpapers.

To upload new wallpaper, follow below steps:

1. Access WP820 Web GUI → Phone Settings → Wallpaper Setting.
2. Press Upload button and select the file to use.

Note: WP820 support JPG, PNG, BMP format, size ≤ 2MB (Best Pixel: 240 * 320px)

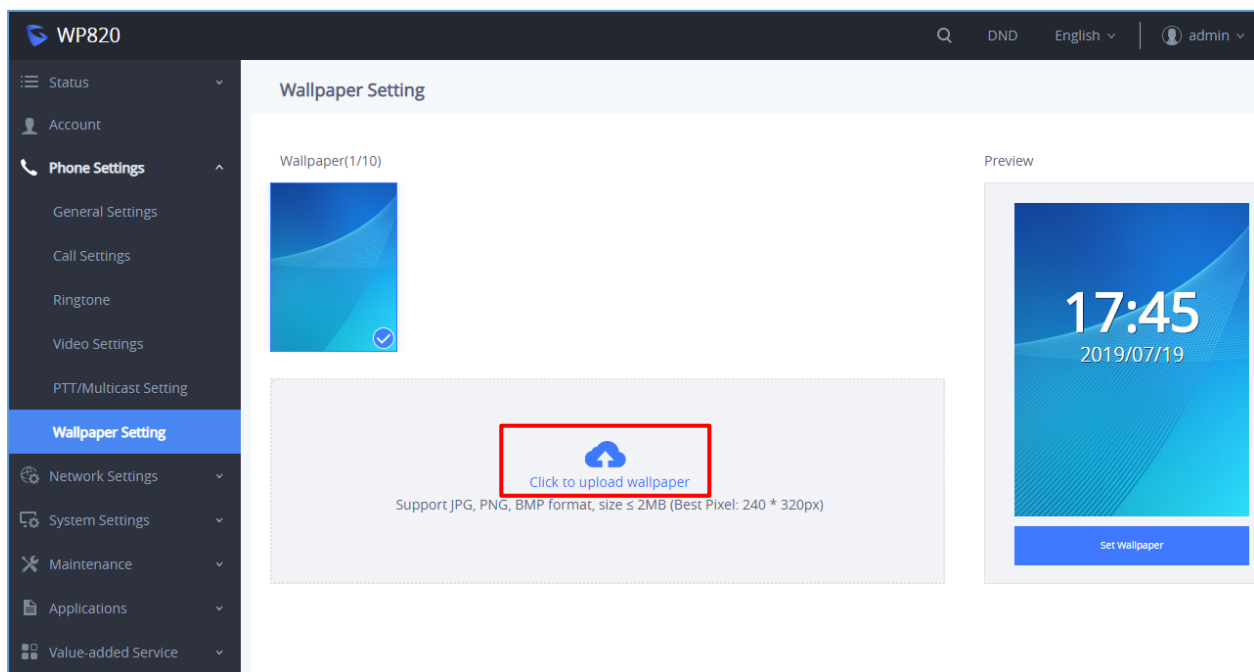

Figure 39: Wallpaper Settings

3. Select **“Display Mode”**: **“Default”** or **“Adaptive”** to adjust displayed wallpaper (effective when uploaded file is not respecting recommended resolution).



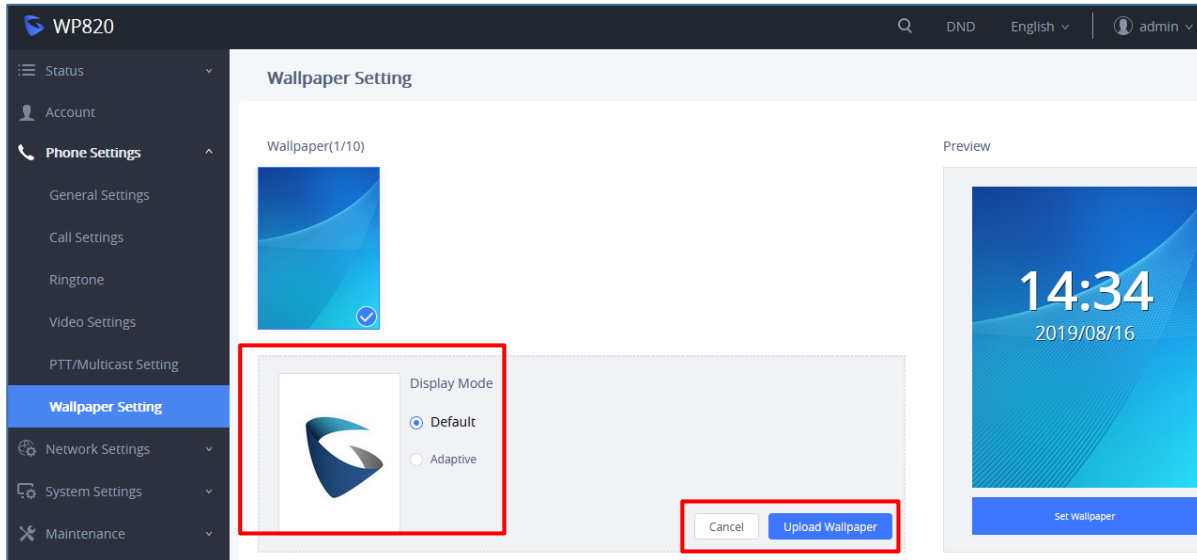

Figure 40: Wallpaper - Display Mode

4. Press “Upload Wallpaper”.

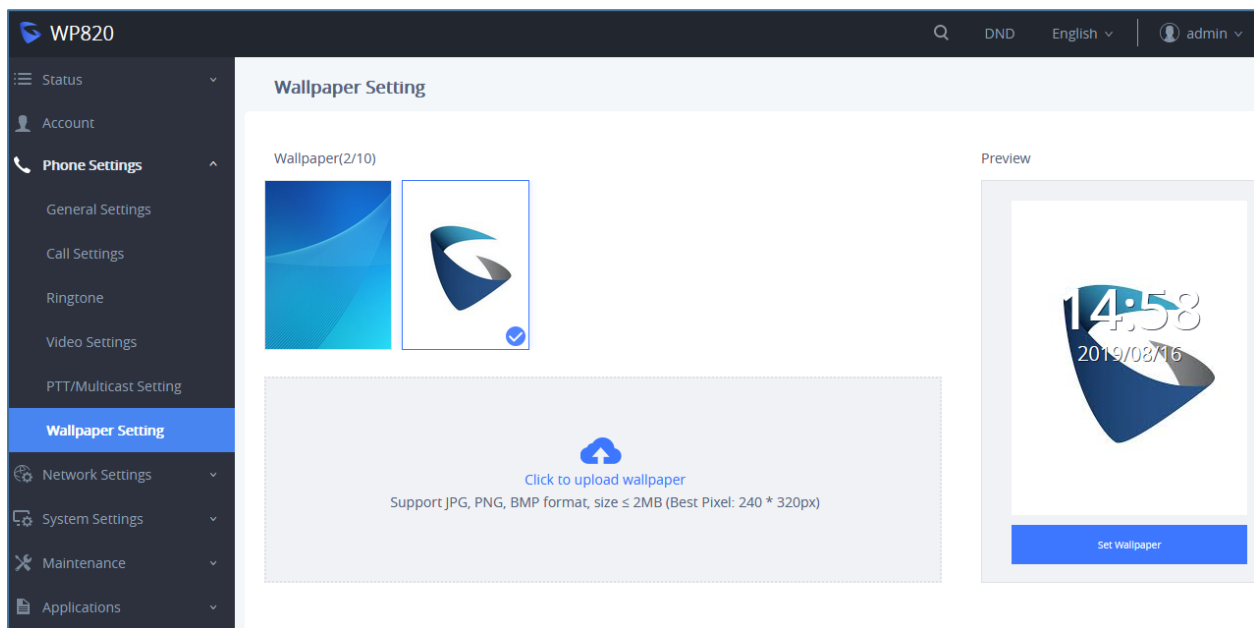

Figure 41: Wallpaper - Uploaded

Applying Uploaded Wallpaper

To apply uploaded wallpaper, follow below steps:

- **From Handset:**
 1. Access WP820 menu → Basic Settings → Wallpaper.
 2. Select uploaded wallpaper and press OK button or “Preview” (left softkey)
 3. Press “Set Wallpaper” (left softkey) to apply.



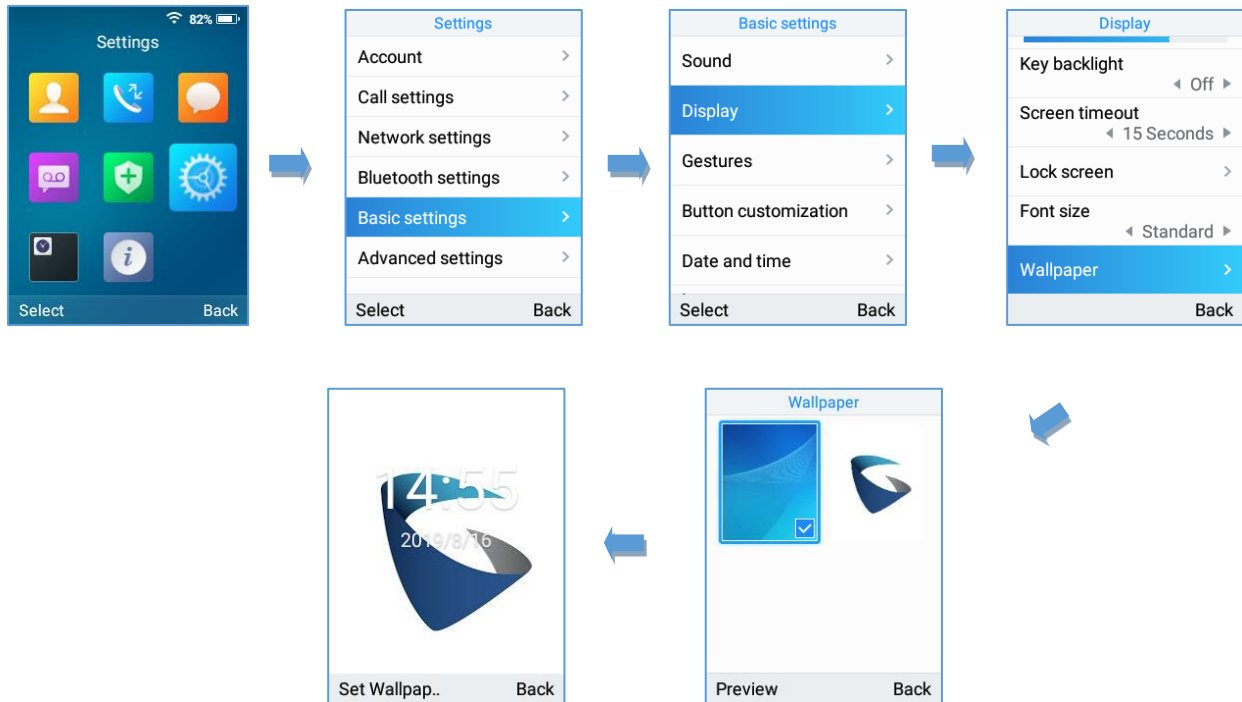

Figure 42: Switching Wallpaper from Handset

- **From Web GUI:**

1. Access WP820 Web GUI → Phone Settings → Wallpaper Setting.
2. Select uploaded wallpaper and press “Set Wallpaper”.

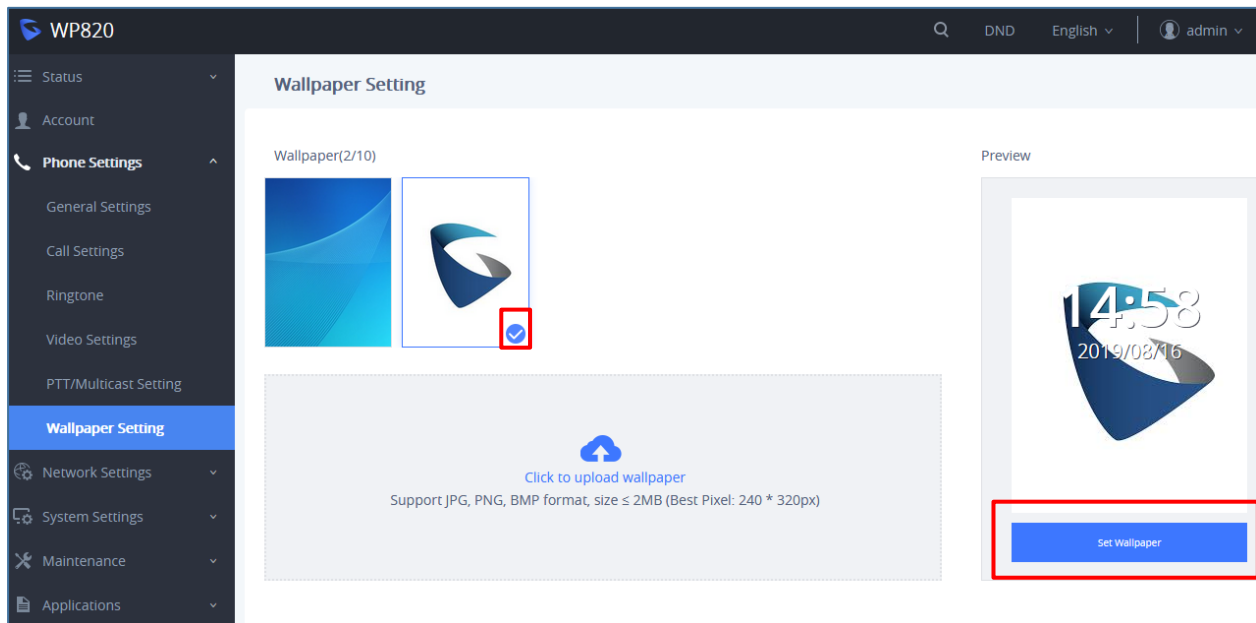



Figure 43: Switching Wallpaper from Web GUI



Deleting Wallpaper

To delete previously uploaded wallpaper, refer to following steps:

1. Access WP820 Web GUI → Phone Settings → Wallpaper.
2. Press  button to delete specific wallpaper.

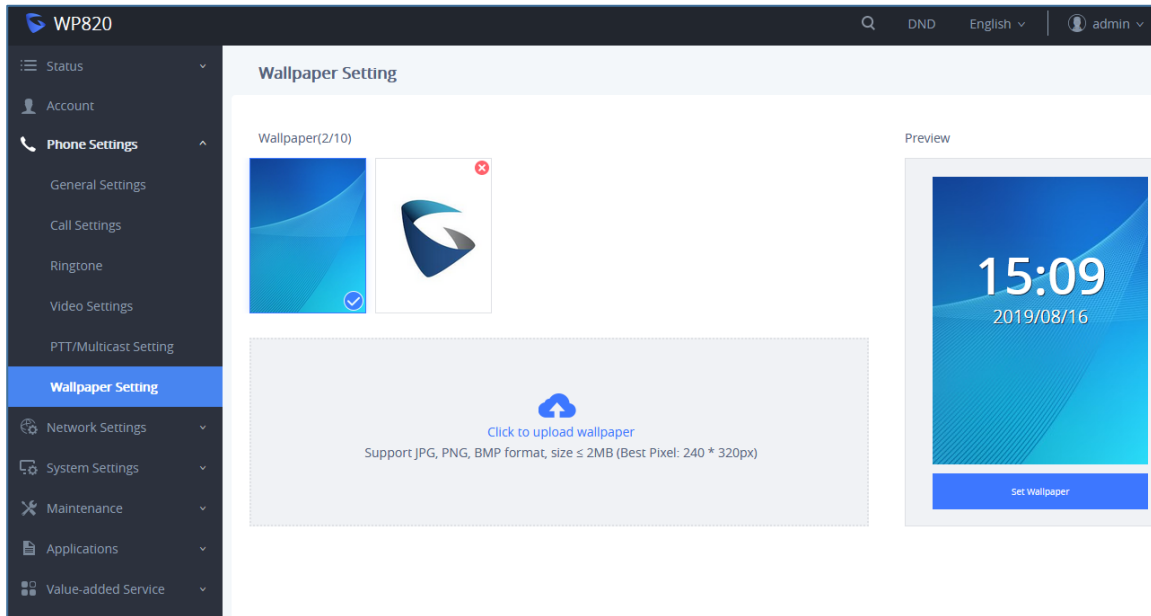

Figure 44: Deleting Wallpaper

Notes:

- The default wallpaper cannot be deleted. Only uploaded wallpapers can be deleted.
- Currently used wallpaper cannot be deleted.

Reboot the WP820

To reboot the WP820, please refer to following steps:

1. Access WP820 menu → Settings → Advanced Settings → Reboot.
2. A confirmation LCD message will be displayed to confirm the reboot, press “**Reboot**” button to reboot the phone or “**Cancel**” to cancel the reboot.

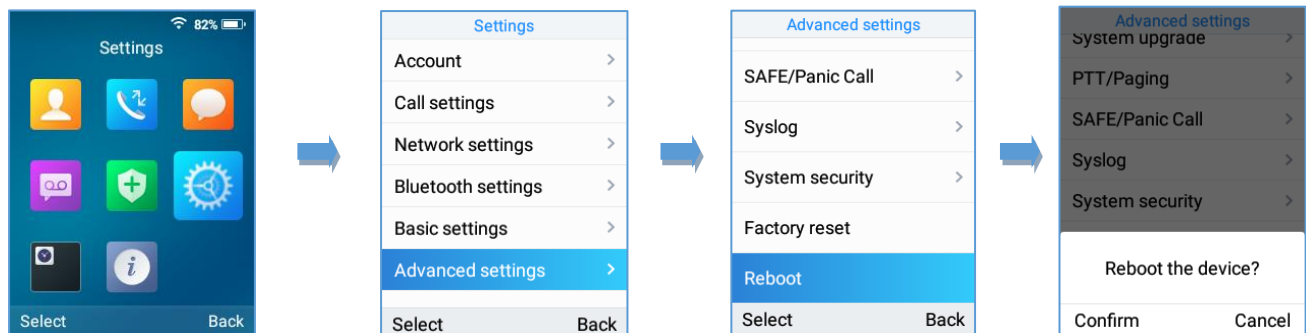

Figure 45: Reboot the WP820



CALL OPERATIONS

Placing calls

To place calls, you can use the following mode:

- **Earpiece mode:** pressing the off-hook / dial key to dial out.
- **Speakerphone mode:** pressing the speakerphone key to dial out.
- **Headset mode:** pressing the off-hook / dial key to dial out using connected headset.

During the call, you can switch the call mode by pressing the corresponding keys or connecting a headset.

Make a Call using a Line

Making calls require the use of SIP lines. So, you should first register the SIP account to the handset beforehand, after registering the sip lines, you can choose between them while trying to make calls by pressing the “**Accounts**” button displayed on the call screen. Please refer to the following methods to make calls using a line:

Method 1:

1. Enter the desired number using the keypad.
2. Toggle between the available lines by pressing the “**Accounts**” button to choose the line for making calls. (The account name will change on the screen when press “Accounts” button).
3. Press **Dial key** , left softkey “**Call**”, # (Use # as dial key” must be configured in web configuration) to initiate the call or wait for 4 seconds and the call will be initiated automatically.



Note: Users can also initiate calls with handsfree mode using **Speaker key** .

4. To terminate the call, press **Hang-Up key** .

Method 2:

1. Press **Dial key** or **Speaker key** to enter the pre-dialing screen.
2. Toggle between available lines by pressing the “**Accounts**” button to choose the line for making calls. (The account name will change on the screen when press “Accounts” button).
3. Enter the number to dial using the keypad.



4. Press **Dial key** , left softkey “**Call**”, # (Use # as dial key” must be configured in web configuration) to initiate the call or wait for 4 seconds and the call will be initiated automatically.
5. To terminate the call, press **Hang-Up key**  .

During the call, you can switch the call mode by pressing the corresponding keys and cancel the dialing operation by pressing the on-hook key. During the call conversations, you can press the left and right navigation keys to adjust the volume. The call duration is displayed on the LCD screen while the call is in progress and call summary will be displayed once the call is terminated.

Notes:

- To dial “+” please keep pressing “0” key for about 2 seconds.
- To dial from contacts list, choose a contact using navigation keys and press **Dial key** .
- When having un-read voicemails on the WP820, once accessing the dialing interface a stutter tone will be heard to notify users about voicemails that need to be read.
- The maximum length of dialed digits is limited to 30 characters.

Dialing from Call history

Users may use their call history entries to initiate calls. Please refer to following steps:

1. Press **Menu** to bring up operation menu.
2. Use arrow keys to reach **Call History**.
3. Select the desired entry and press **Dial** key to establish the call.

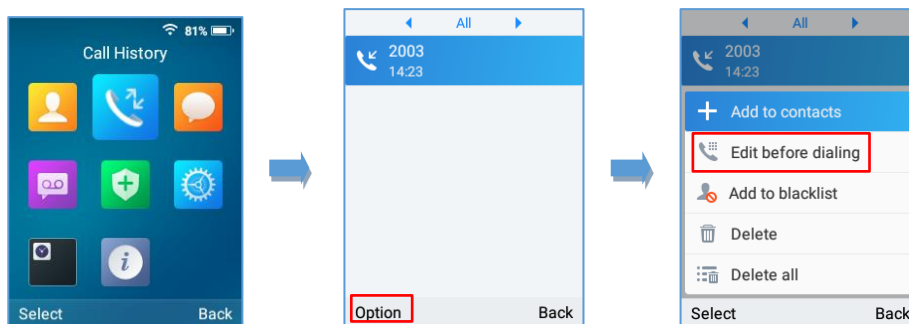



Figure 46: Dialing from Call History

Note: In step 3, users can press “**Options**” softkey followed by “**Edit before Dialing**” option to edit the number before initiating the call. The call history list stores the last dialed phone numbers. When the memory of the redial number list is full, the handset will automatically erase oldest dialed number when a new number is dialed.

Dialing from Phonebook

Users may use their contacts list to initiate calls.

1. Press **Menu** to bring up operation menu and use arrow keys to reach **Contacts** or press **Contacts**

key  to access directly the contacts list.

2. Select the contact to call and press **Dial Key** to initiate the call.

Note: In step 2, users can press “Options” softkey followed by “Edit before Dialing” option to initiate the call.

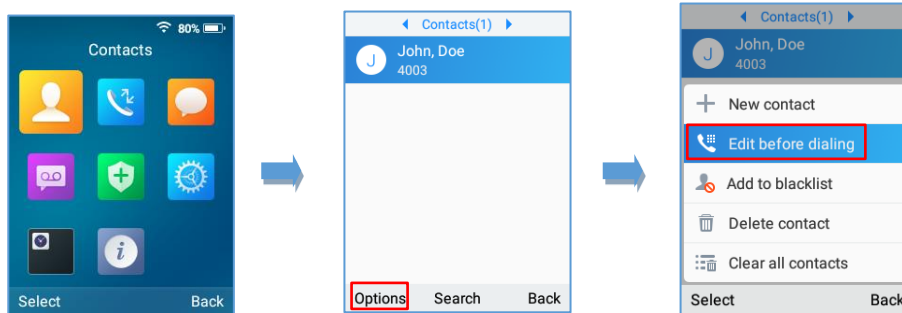

Figure 47: Dialing from Contacts List

Answering Calls

When receiving an incoming call, you can answer the call using following steps:

- **Earpiece mode:**
Press **Dial Key** to pick up the call, or “Accept” softkey (left softkey).
- **Speakerphone mode:**
Press **Speaker Key** to pick up the call.
- **Headset mode:**
Press **Dial Key** to pick up the call, or “Accept” softkey (left softkey) using a connected headset.

Note:

To answer an incoming call during an established call, press **Dial Key**, or the **Speaker Key**, or the “Answer” softkey. The incoming call is answered, and the original call is placed on hold.

Auto Answer

Users can enable Auto Answer feature to accept and automatically answer incoming calls.

If enabled, the WP820 will automatically answer incoming calls using speaker mode.

To activate / deactivate the auto answer feature:



- **Using WP820 LCD Menu**

1. Press **Menu** to bring up operation menu.
2. Use arrow keys to reach **Settings → Call settings → Auto answer**.
3. Select which account will be enabling the Auto answer feature.
4. Set “**Auto-Answer**” to “**On**” and configure the auto-answer mode and press “**Save**” button.

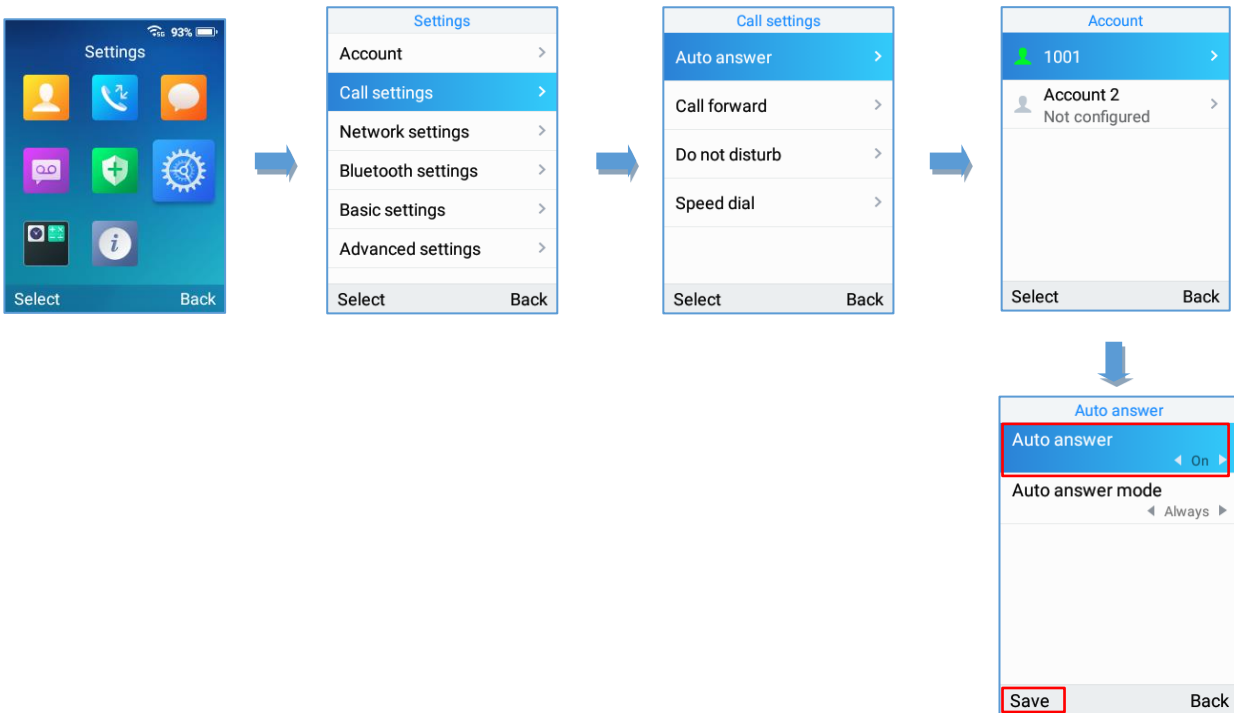

Figure 48: Auto-answer on WP820

Note: The auto-answer icon will be displayed near of the account on the LCD screen when the Auto-answer feature is enabled on the configured accounts as displayed on the following screenshot.

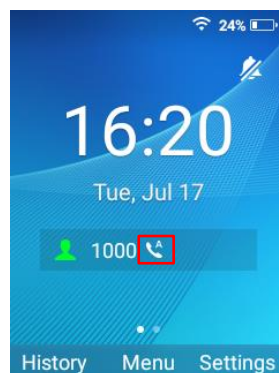

Figure 49: Auto-answer Idle Screen

- **Using WP820 Web Interface**

1. Access WP820 Web GUI Interface.



2. Navigate to **Account** → **Call Settings** → **Call features**.
3. Set “Auto Answer” to “Yes”. (By default, set to “No”).

Ending Calls

To terminate the calls, press **Hang-Up** key  .

Rejecting Calls

To reject an incoming call, press **Hang-Up** key  .

Call Hold/Resume

- During active call, press the right softkey “**Hold**” to put the established call on hold.
- To resume the call, press the right softkey “**Unhold**” while the established call is being on hold.

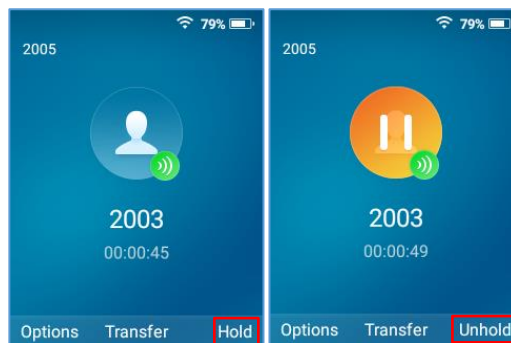

Figure 50: Hold/Unhold Calls

Notes:

- If you press on “Options” during the established call, and then make a new call to another number, the first call will be on hold automatically and users can put up to 2 calls on hold at the same time.

Call Waiting

This feature will notify you of a new incoming call during an established call and display the incoming call information visually on the LCD screen and a call waiting tone will be heard. If this feature is disabled, the new incoming call will be automatically rejected.

This feature is enabled from the WP820 Web GUI:

1. Access WP820 Web Interface.
2. Go to **Phone settings** → **Call Settings**.



3. Set “**Disable Call Waiting**” and “**Disable Call Waiting Tone**” to “No”. (Default is No).
4. Press Save and Apply buttons to confirm the new settings.

Users now will be able to hear the call waiting tone and it will be visible as well on the LCD screen as displayed on the following screenshot.

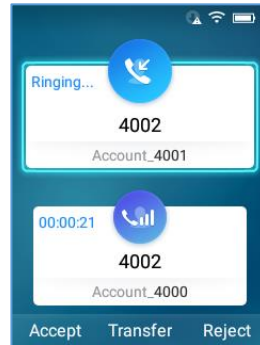

Figure 51: Call Waiting

Do Not Disturb

You can activate or deactivate the DND mode for your accounts registered on the handset from its LCD menu. If DND mode is activated, all incoming calls will receive busy treatment depending on your configuration (forward to voice mail, busy tone...).

To enable or disable the DND mode, Access LCD Menu → **Settings** → **Call Settings** → **Do not disturb** and set **Do not disturb** to **On**.

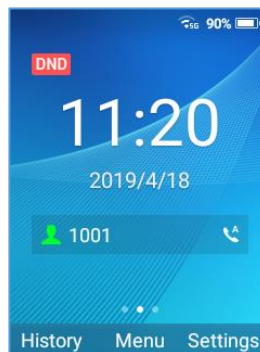

Figure 52: DND Enabled

Call Forward

The call forward feature will allow you to forward all the incoming calls to the desired number. Three possible call forward types are available on the WP820.

- **Unconditional:** All the incoming calls are immediately forwarded to the desired number.



- **Time Based:** Incoming calls are immediately forwarded to the desired number based on the configured time.
- **Others:** Incoming calls are forwarded to the desired number when Busy, when DND is enabled or when there is no response.

To enable the call forward, please refer to the following steps:

1. Press **Menu** to bring up operation menu.
2. Use arrow keys to reach **Settings → Call Settings→ Call forward**.
3. Select which account will be enabling the call forwarding feature and navigate to **“Call forwarding”**.
4. Set **“Call Forward”** to **“On”** and select the call forwarding mode.
5. Configure the parameters of the call forward mode and press **“Save”** button.

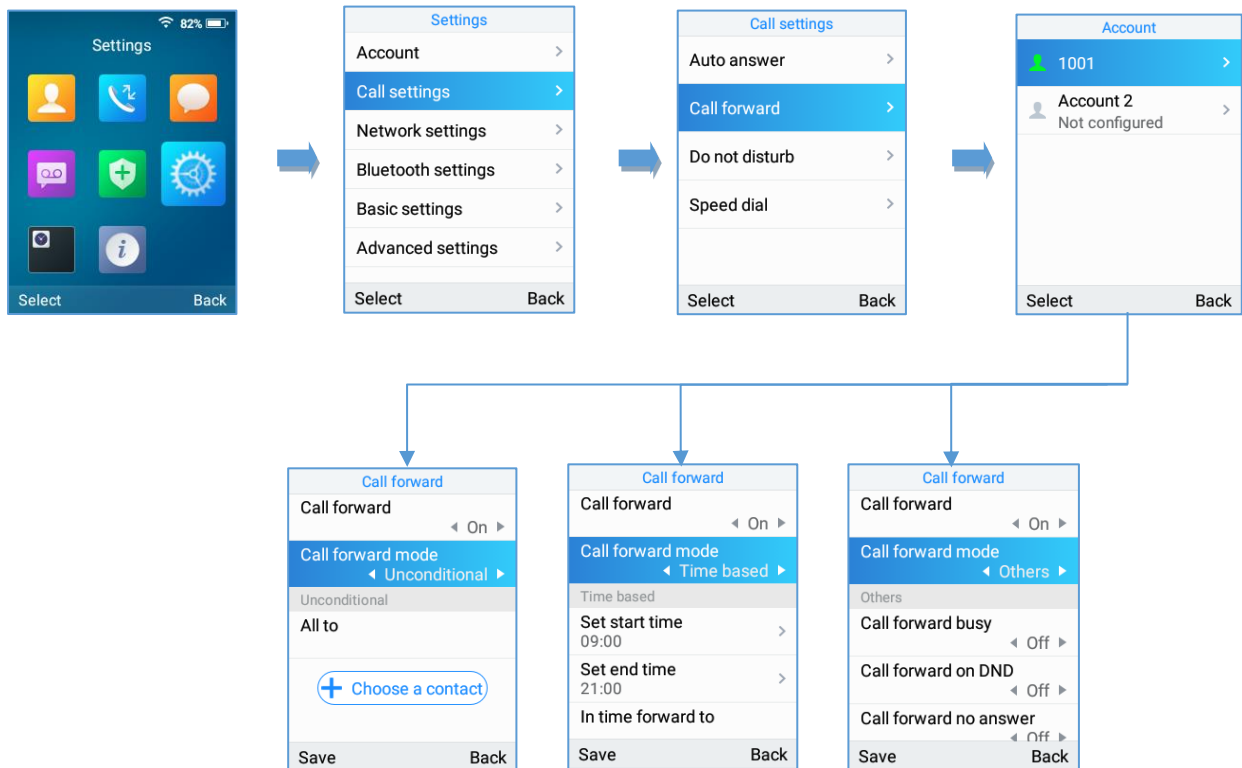

Figure 53: Call Forwarding

- **Unconditional:** All the incoming calls will be forwarded to the number set up in "All To" field.
- **Time Based:** All the incoming calls will be forwarded to the number as schedule in the time period.

During the setup time, the call will be forwarded to the number in "In Time Forward To:" field. Other period the call will be forwarded to the number in "Out Time Forward To:" field.

- **Others:** The incoming call will be forwarded when the WP820 is busy or no answer after certain interval "Delayed Call Forward Wait Time (s)" or if the phone is set to DND mode.

Note: The call forwarding can be also configured from the **WP820 Web GUI → Account → Call Settings**.

Call Transfer

The WP820 supports the call transfer feature, you can transfer a call to another party using one of the following ways:

- **Blind transfer:** Transfer a call directly to another party without consulting
- **Attended transfer:** Transfer a call with prior consulting.

Blind Transfer

1. Press "Transfer" softkey during a call, and then enter the number you want to transfer the call to.
2. Select Blind transfer by pressing on **Blind** key.
3. The call is connected to the number you specified, and the LCD screen prompts Call Transferred.

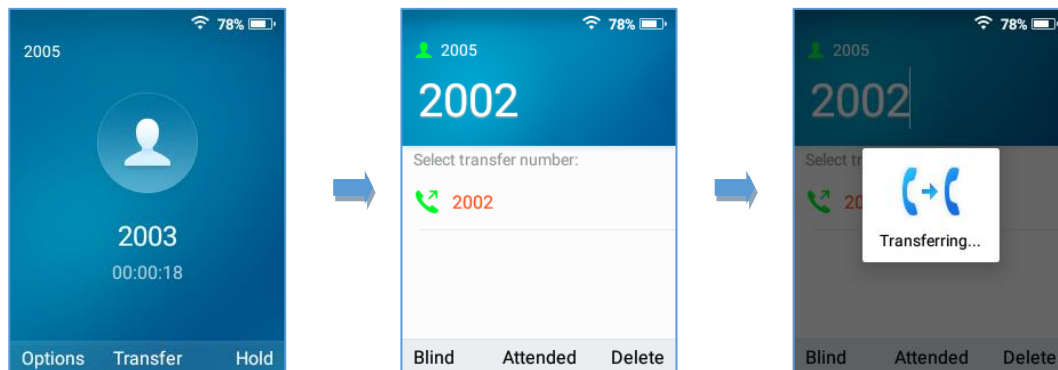

Figure 54: Blind Transfer

Attended Transfer

1. Press "Transfer" softkey during a call, and then enter the number you want to transfer the call to.
2. Select Attended transfer by pressing on Attended key.

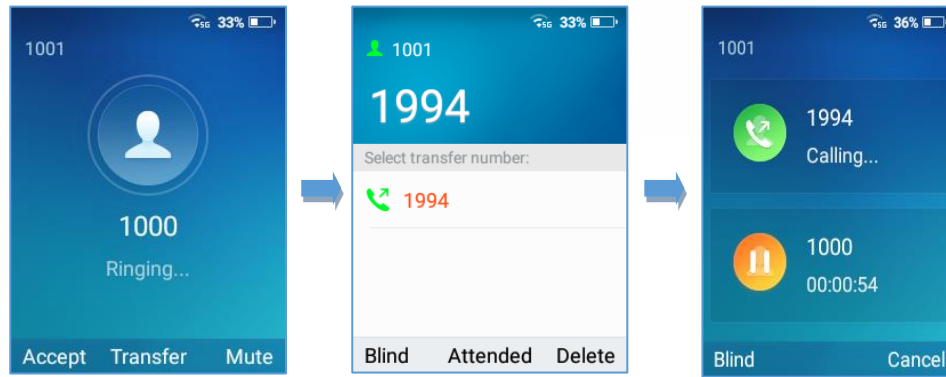

Figure 56: Attended transfer

3. After transfer target answers the call, the following screen will be shown up. If the transferor taps on Confirm, the call will be transferred, and the WP-820 will hang up the call.

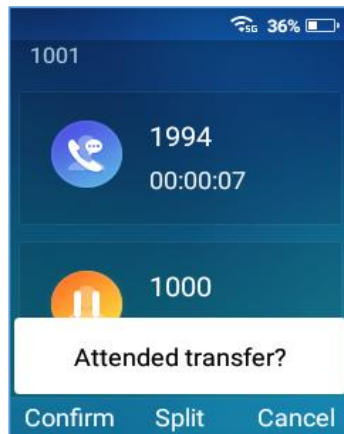

Figure 55: Attended transfer options

4. If the user taps on "Split" soft key to separate the calls, the user will talk to the second established call while the first call is on hold.



Figure 57: Split Calls



Speed Dial

Speed dial allows users to perform single-digit dialing to predefined numbers. This feature is particularly useful to speed up dialing frequently used or hard to remember numbers. A maximum of 10 speed dial numbers is allowed. For example, the digit key 2 is configured as a speed dial key and assigned the number 4000, the phone will dial out the number 4000 directly when you long press digit key 2.

Note: The speed dial number should not be set on chosen representative number, otherwise long press will initiate a call to configured speed dial number.

To configure the speed dial (create, edit or delete) numbers, proceed as the following steps:

1. Press **Menu** to bring up operation menu and use arrow keys to reach **Settings** → **Call Settings** → **Speed dial**.

2. Select the speed dial key to be configured and press “**Select**” softkey.
3. Select the associated account and the number to be dialed.

Note: Users can also select the numbers from the contact list by selecting “Choose a contact”.

4. Press “**Save**” softkey to save the configured speed dial numbers.

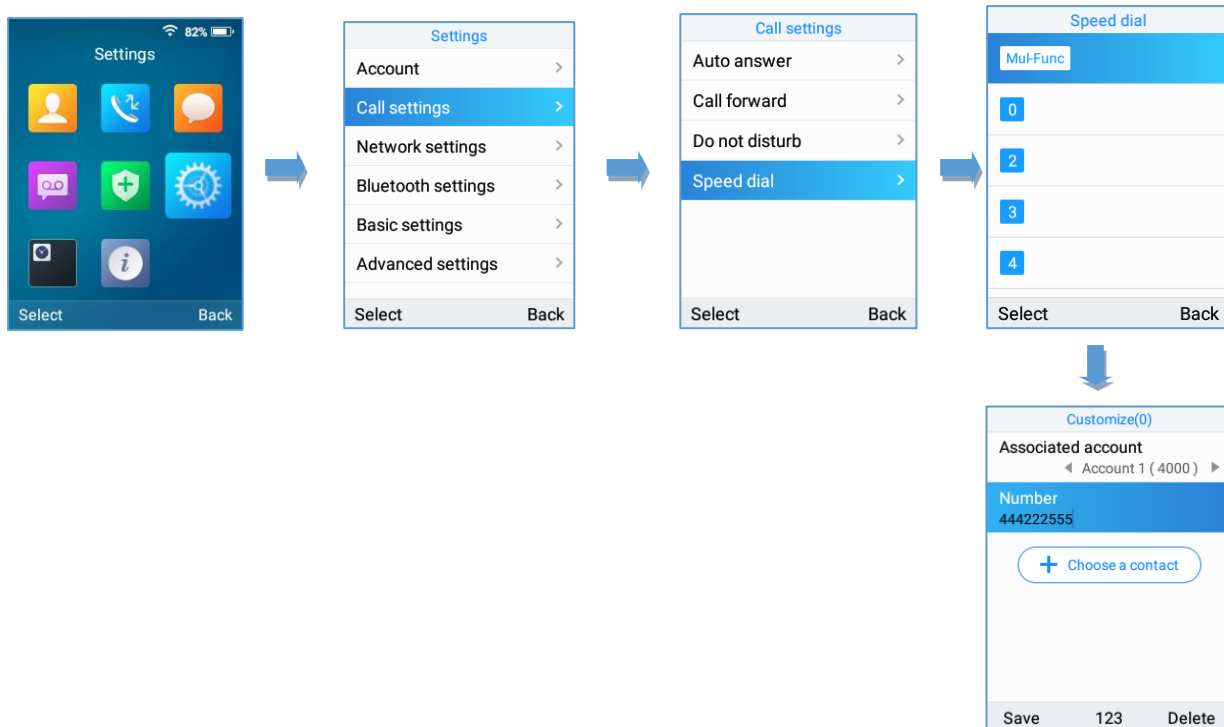

Figure 58: Speed Dial Configuration

3-Way Conference

The WP820 supports creating a local conference with other parties (including handset starting the conference). To start a 3 Way conference, follow below steps:

1. Place a call to the first party and press left softkey “**Options**”, then select “**Conference**”.
2. Enter the number of the second party you want to add to the conference and press **Join Conf.**
3. The conference will automatically be bridged before the third party answers the call.

Please refer to the following screenshots for more details.

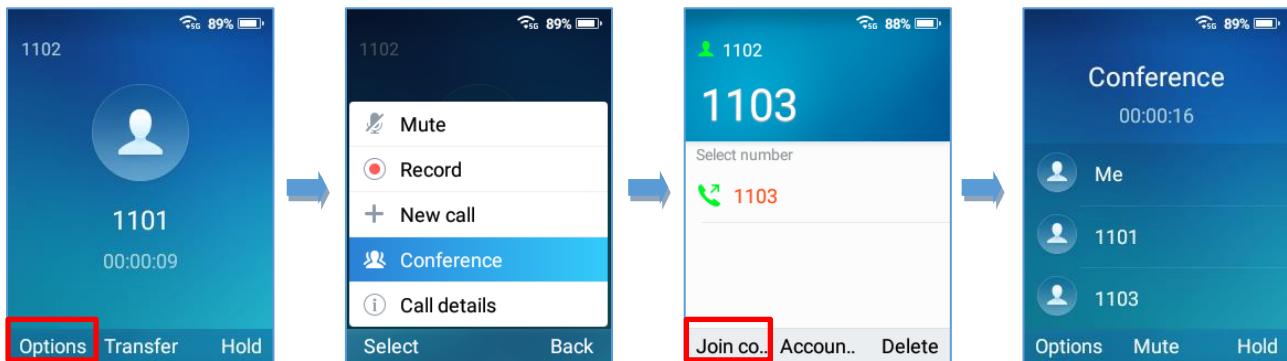

Figure 59: 3-way Conference Call

Notes:

- Users can start recording the conference by tapping on “Record” under “Options”.
- Users can kick one of the parties from the conference by tapping on “Kick [Extension]” under Options.

UCM Conference

Participate in UCM Conference Room

Users could dial the UCM conference room extension to join the conference. If password is required, enter the password to join the conference as a normal user, or enter the admin password to join the conference as administrator.

Note: Number of current participants is shown starting from firmware release 1.0.5.5.





Figure 60: Join UCM Conference Room

Conference Call Operations

- View conference participants: Users could press on **UCM** key in order to view the conference participants.

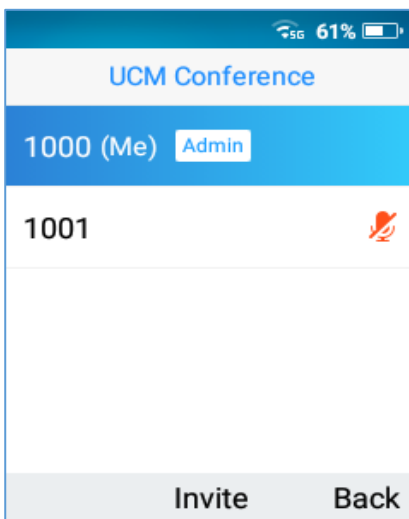

Figure 61: UCM Conference Participants

- Invite members: Administrators could press on **UCM** softkey during the conference and then press on **Invite** in order to send and meeting invitation to the composed number. Press on **Invite** after entering the number.



Figure 62: Send meeting invitation

Note: If the 'Require confirmation' parameter is On, the invited party will need to confirm before joining the meeting conference.

- Mute/Unmute a participant: Administrators could select a member and press on **Options** → **Mute/Unmute** a participant.
- Kick a Participant: Administrators could select a member and press on **Options** → **Kick** a participant from the conference.

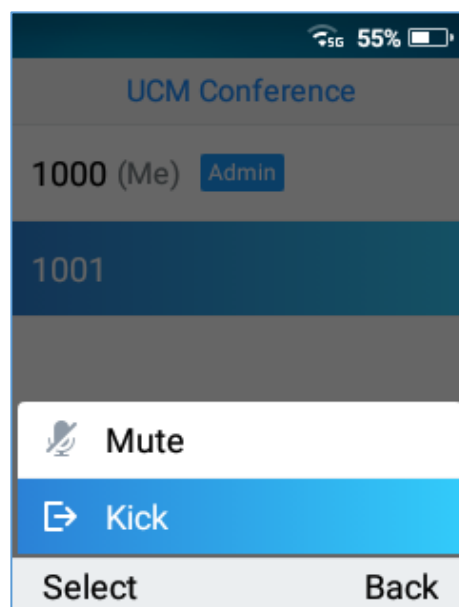

Figure 63: Kick a participant

CEI (Conference Event Indicator)

If CEI is enabled, Events like members joining/Leaving the conference, Invitation sent, Mute/Unmute ... will be displayed in the call screen as the examples shown below:

- Member has joined notification:

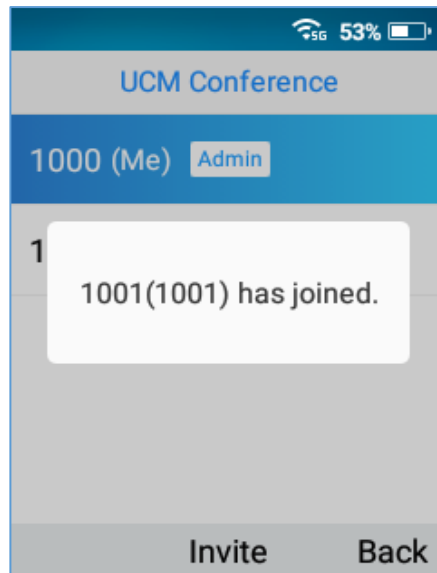

Figure 64: Member has joined notification

- Member Mute notification:

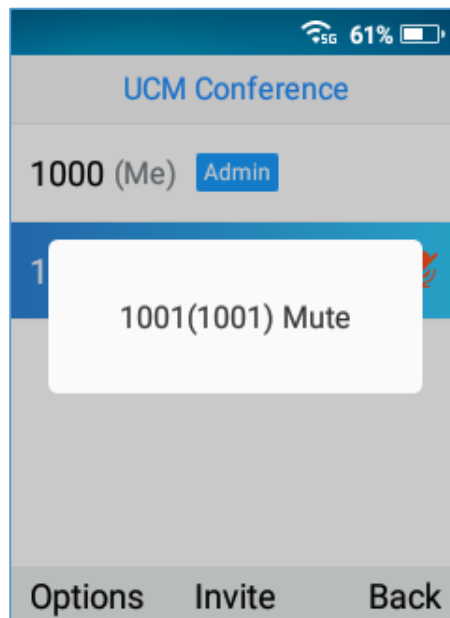

Figure 65: Member Mute notification



- Member Left Notification:

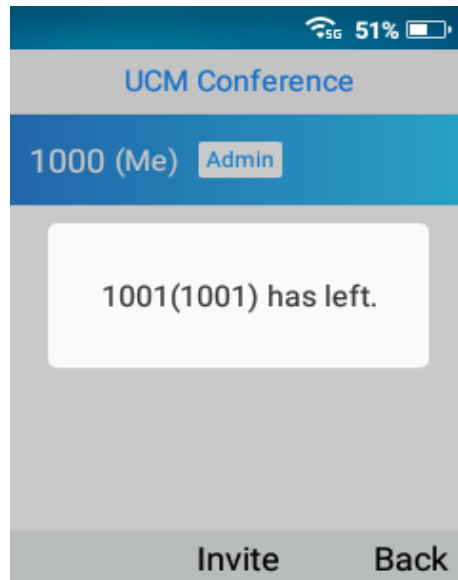

Figure 66: Member left notification

Voice Mail

The voice mail feature ensures that you will never miss any important messages. It permits either to leave voice mails to someone else or receive and listen to voice mails via the handset

Set Voice Mail ID

There are 2 ways to set Voice Mail Feature Code, either using WP820 Handset Menu or Web Interface.

Note: The Voice Mail Feature Code depends on the service provider or IP-PBX used. For example, if UCM6xxx as SIP server, the Voice Mail Feature Code is *97.

- **Using WP820 LCD Menu**

1. Press **Menu** to bring up operation menu.
2. Use arrow keys to reach **VoiceMail** tab.

Note: You can access the **VoiceMail** tab by long pressing on digit "1".

3. Select the desired account and configure the **VoiceMail ID** number, then press "**Save**" softkey.

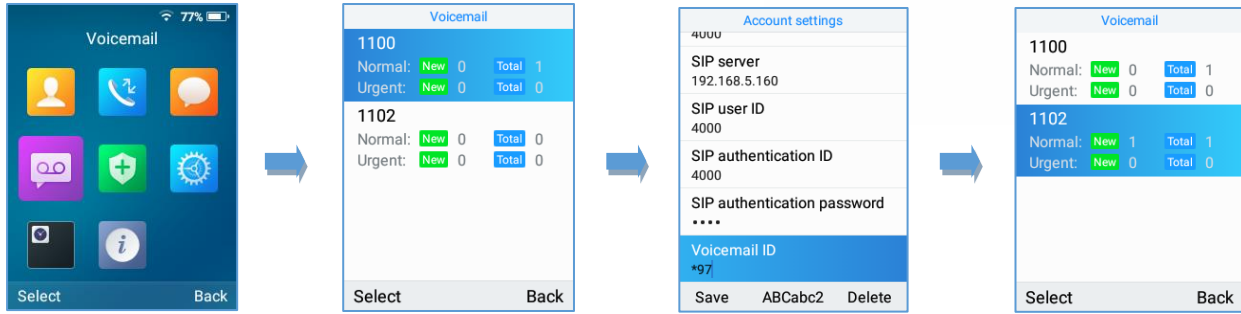

Figure 67: LCD Menu - Voice Mail ID

- **Using WP820 Web Interface**

1. Access WP820 Web GUI Interface.
2. Go to Account → General Settings → Account Registration.
3. Configure **Voice Mail Access Number**.

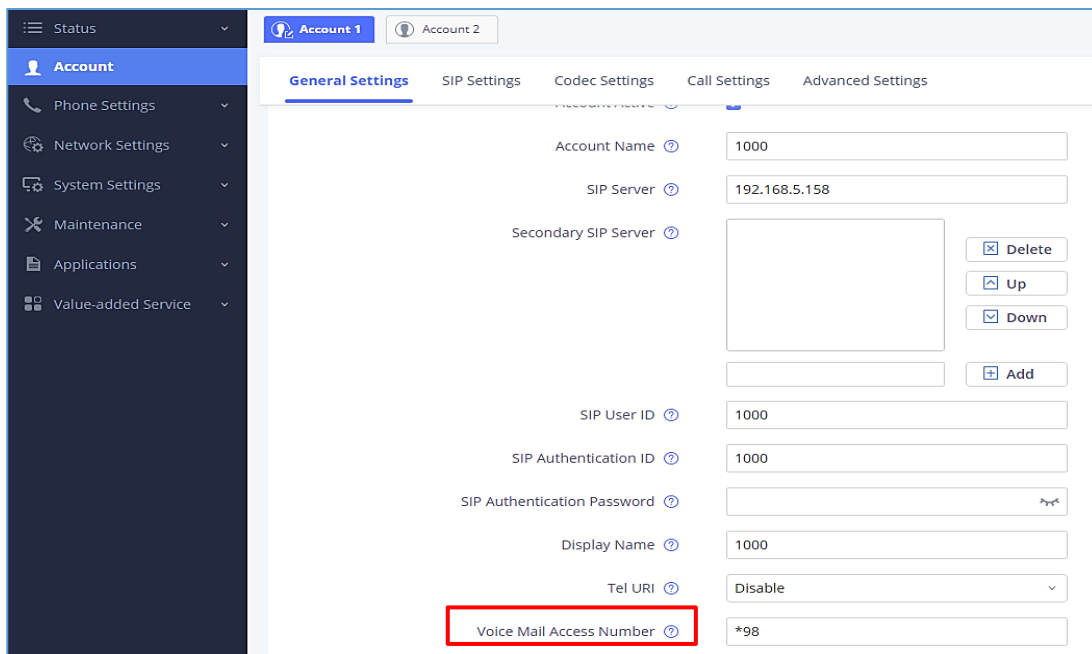

Figure 68: Web UI - Voice Mail Access Number

Play Voice Mail Messages

1. Press **Menu** to bring up operation menu.
2. Use arrow keys to reach **VoiceMail** tab.
Note: You can also access the **VoiceMail** tab by long pressing on digit "1".
3. Choose the account, press "**Select**" button and enter Voicemail password then to can select visually and retrieve your voice messages saved on your voice mail and listen to each individual voicemail.
Note: this feature is compatible with UCM6xxx on v.1.0.20.6 or later.



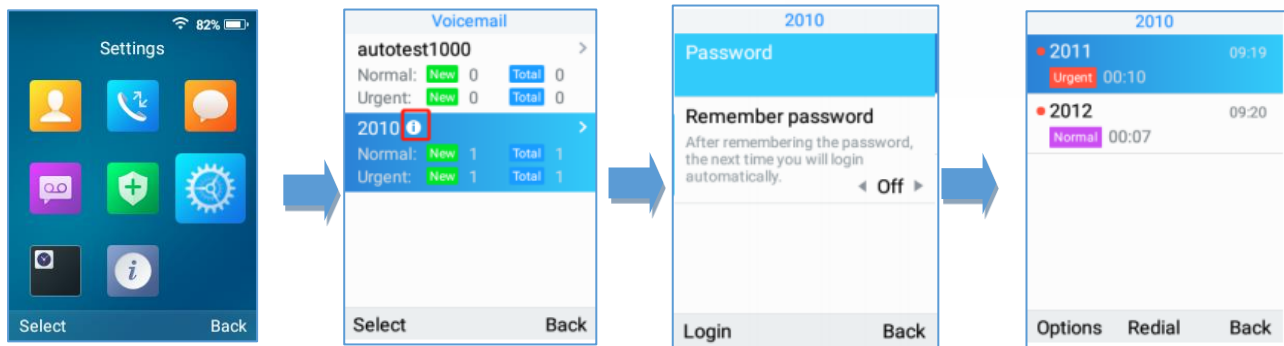

Figure 69: Playing Voicemail Messages

Notes:

- If VM is protected by a password, users can enter the password using WP820 keypad after reaching Voice Mail system. The password is defined on the service provider or IP-PBX side.
- When having un-read voicemails on the WP820, once accessing the dialing interface a stutter tone will be heard to notify users about voicemails that need to be read.

CONTACTS

Users can manage local/LDAP and Broadsoft XSI contacts, groups, and blacklist by adding, deleting and modifying every single contact. Users could access WP820 contacts under WP820 Menu. *Please, refer to the following screenshots:*

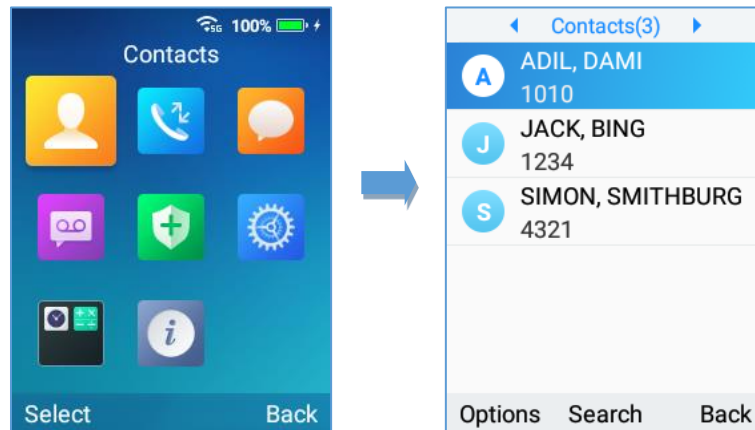

Figure 70: Accessing Contacts

Notes:

- Users could switch between “Local Contacts”, “LDAP Contacts”, “Local Groups” and “Blacklist” by using the right and left arrow buttons from the handset.
- The WP820 supports 1000 contacts as maximum number of local contacts.

Local Contacts

Users can manage local contacts by adding, deleting and modifying single contacts. The following operations can be done under local contacts screen:

- **Create new contact:** Under “Option”, users can select “New Contact” in order to manually add the contacts information and details. *Please, see the following screenshots and table:*

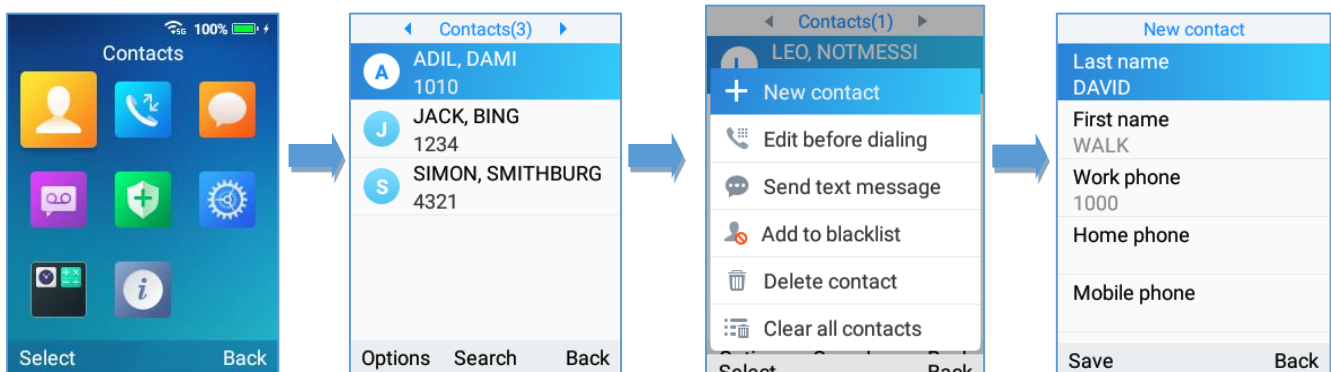



Figure 71: Create a new contact



Table 12: New Contact Parameters

Last Name	Enter the contact's last name.
First Name	Enter the contact's first name
Work Phone	Enter the contact's work phone number.
Home phone	Enter the contact's home phone number.
Mobile phone	Enter the contact's mobile phone number.
Group	Choose the group you want to include your contact into.
Ringtone	Choose a specific ringtone for the account's received calls.
Account	Choose the default account you want to dial with this contact.
Address, company, Rank, Department and Title	Additional information.

- **Search for a contact:** in case finding a specific contact among a batch of contacts is difficult, users can press the middle softkey "Search" and enter the name of the contact to find it easily or use the quick search feature and press on any keyboard key in order to enter the search mode.
- **Dial out from Contacts:** Select the needed contact, and tap on the dial key  to call it directly. The phone will use the configured account on contact's information to dial out with.
- **Edit before dialing:** Users could copy the contact's number to the dial screen in order to edit it before dialing.
- **Add to blacklist:** Users have the ability to block received calls from a specific contact from by adding it to Blacklist.
- **Delete contact:** Users can delete a specific contact by tapping on "Delete contact".
- **Clear all contacts:** Users can delete the whole list of local contacts by tapping on "Clear all contacts".

LDAP

In addition to local contacts, the WP820 also supports LDAP and LDAPS phonebook if LDAP or LDAPS server is available within the network. *For more information about LDAP configuration on the WP820 Web GUI, please, refer to WP820 Administration guide.*

In order to search for LDAP contacts on the WP820, users need to access "Contacts", switch to "LDAP" using the right/left arrow buttons on the handset, and show the search field by tapping on "Search".



Groups

Open Contacts and switch to “Groups” using the right/left arrow buttons on the handset. To add a new group, tap on **Options→New group**.

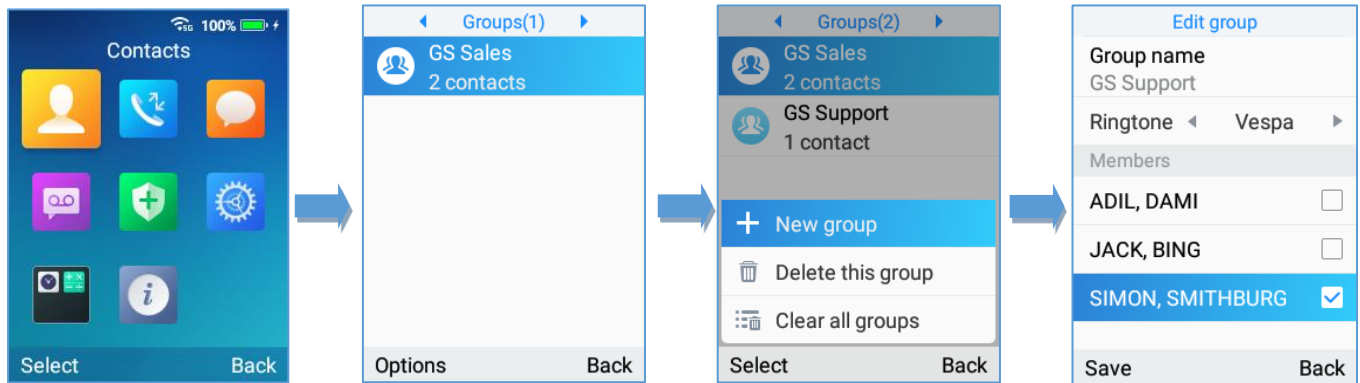

Figure 72: Create New Group

Users should enter the following information when creating a new group:

- **Group Name:** Enter the name of the group.
- **Ringtone:** Choose the ringtone that will be assigned to the group.
- **Members:** Choose the members of the group.

Notes:

- Ringtone can be assigned in group as well as single contact. If the group’s ringtone is customized, this ringtone has the highest priority when there is an incoming call to the contact.
- Users could select group for contact when adding or editing the contact.
- Users could delete a specific group or delete all groups, this options can be found under “Options”.

Blacklist

Blacklist WP820 has blacklist support for users to manage incoming calls. To access “Blacklist”, tap on “Contacts”, then switch to “Blacklist” using the right/left arrow button on the Handset.

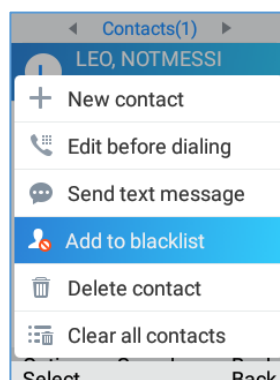

Figure 73: Blacklist

Users can tap on “Remove” to remove a contact or on “Clear” to delete all contacts from blacklist.



BROADSOFT XSI

Users login to their BroadSoft XSI account from the LCD Menu:

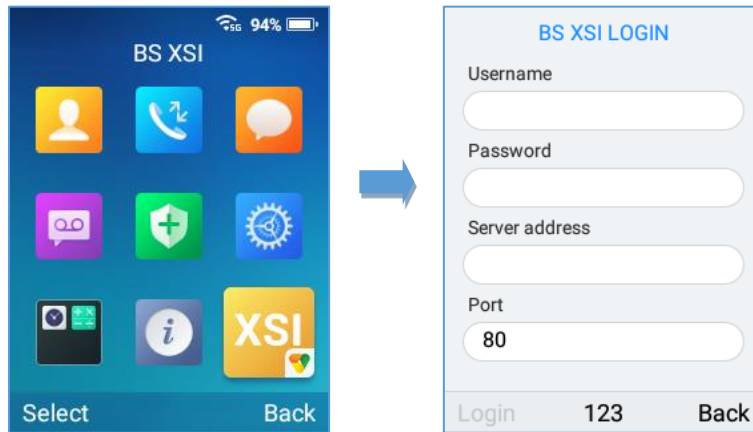

Figure 74: BS XSI Login

Note:

The BroadSoft Contacts will show up at the Contact APP.

CALL HISTORY

The WP820 Call history provides users access to phone's call logs in different categories, and help users to make some operations directly. Call history can be accessed under menu as shown on the following figure:

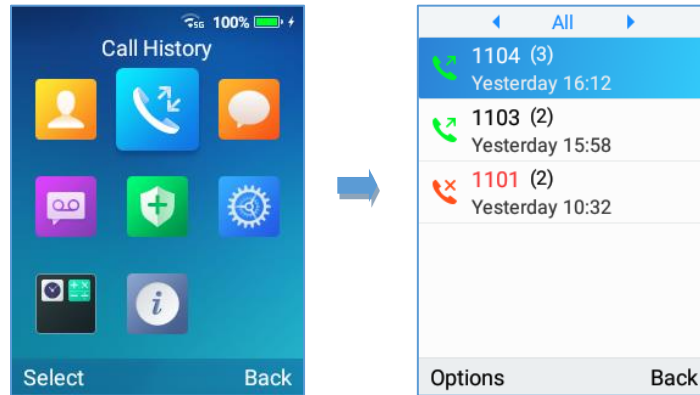



Figure 75: WP820 Call History

There are four different categories in the call history. Users could use the phone's right and left arrows to view the following categories: All Calls, Missed Calls, Outgoing Calls, Incoming Calls.

Dial Out from Call History

Select one of the call history log and tap on the dial key  to call this number directly. The phone will use the same account as the call log to dial out.

Call History Options

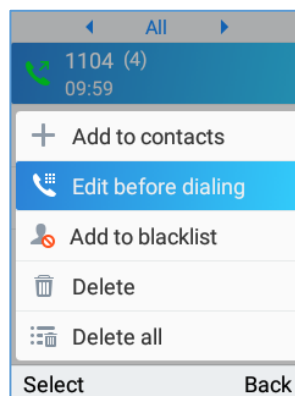

Figure 76: Call History Options

- **Add to contacts:** Users can tap on this option to add the number listed on the selected call history entry to local contacts.
- **Edit before dialing:** Users could copy the number to the dial screen in order to edit it before dialing.

- **Add to blacklist:** Users have the ability to block a number's calls/messages by adding it to Blacklist.
- **Delete:** Users could delete the selected call history log by tapping on "Delete".
- **Delete all:** This option helps users to clear all the call history.

Call History Details

For each call history entry, users could tap on "OK" button to access the details to view the account on WP820 that was called and all the calls that have made/received to/from the selected number. *Please, refer to the following screenshot:*

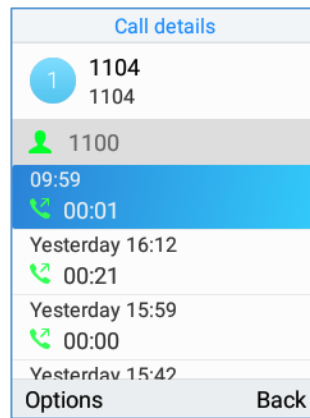



Figure 77: WP8200 Call History Details

The following operations could be done:

- Dial out this number directly.
- Bring up dial screen with the call history number. Users could edit the number before dialing out.
- Delete the entry.
- Add the number to black list by tapping on "Add to Blacklist".

SMS

The WP820 has built-in SMS application to send/receive message, if the SIP server supports SMS message.

Users can create, edit draft and delete one or all the messages. Tap  on phone's menu to launch SMS application.

View SMS

On the SMS list screen, tap on one of the message using the OK button to view the SMS details.

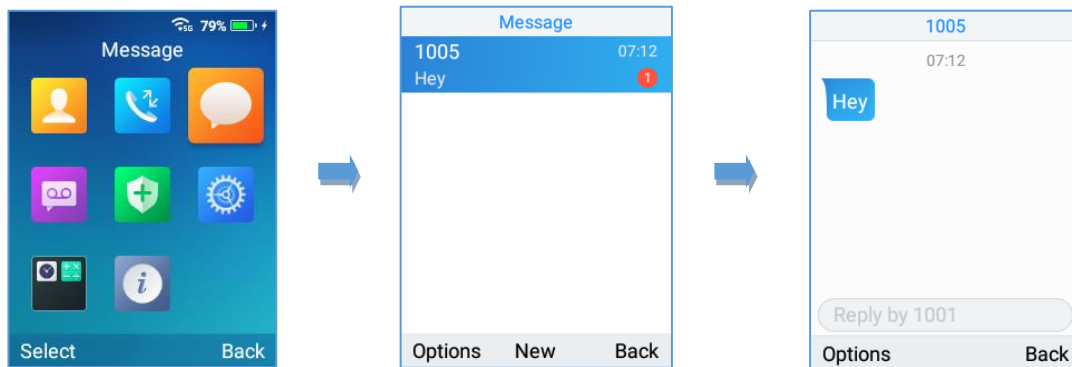

Figure 78: View SMS Dialog

Create SMS

Tap on “New” in SMS application to start composing a new message.

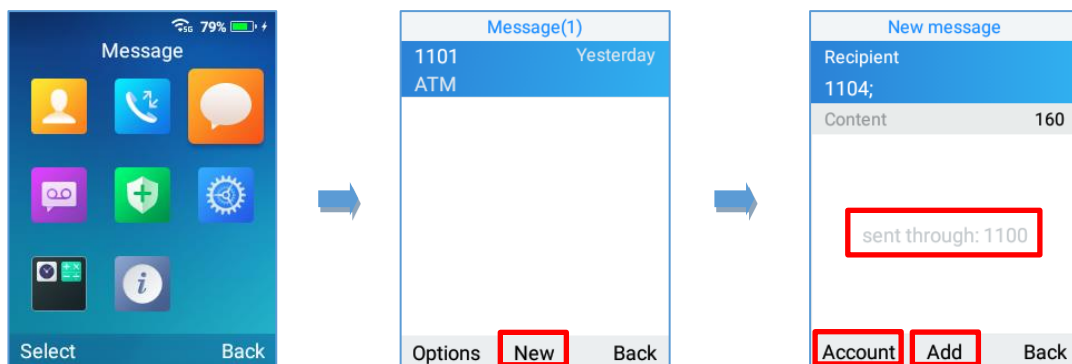

Figure 79: Create a New Message

1. Select the account to send the message from by tapping on “Account”. (**Note:** By tapping on “Account”, the user will switch from the first account to the second one in case both SIP accounts are registered. The account sending the message will be shown in the center of the screen to make sure of it as shown on the figure above).
2. Add number to send the message to in Recipient section. (**Note:** Users could click on “Add” to add

existing contacts/groups to Recipient list.

3. Input content: Enter the message content on the next field of the screen. Tap on "Send" once finished, a "Sending" message will prompt and the message is confirmed as sent once the "Sending" message prompt disappears.

Note:

Creating SMS is doable from Contacts by selecting a contact name, then pressing Options, and then choosing Send text message.

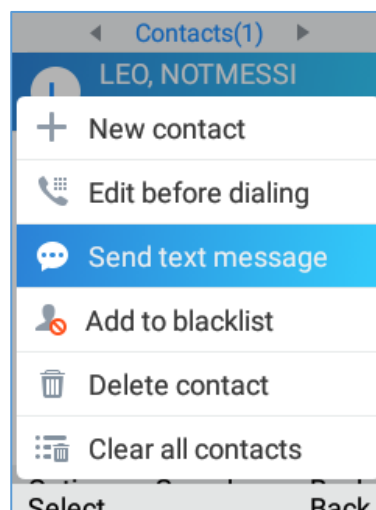

Figure 80: send a New Message from Contact

Delete SMS

1. On the messages list, tap on "Options" to show more options.
2. Tap on "Delete message" to delete the selected message, or on "Clear all messages" to delete all the messages/drafts.

Notes:

- Under "Options", users can also find "Add to contacts" option to directly include the number selected on the local contacts.
- The option "Edit before dialing" under "options" is used to facilitate dialing numbers directly from the SMS application.

CALL FEATURES

The WP820 supports traditional and advanced telephony features including call forward and etc.

Table 13: Call Features

*72	<p>Unconditional Call Forward. To set up unconditional call forward:</p> <ul style="list-style-type: none"> • Off hook the phone; • Dial *72 and then enter the number to forward the call; • Press Call softkey or Dial key.
*73	<p>Cancel Unconditional Call Forward. To cancel the unconditional call forward:</p> <ul style="list-style-type: none"> • Off hook the phone; • Dial *73; • Press Call softkey or Dial key.
*74	<p>Paging Call. To establish a paging call:</p> <ul style="list-style-type: none"> • Off hook the phone; • Dial *74; • Press Call softkey or Dial key.
*90	<p>Busy Call Forward. To set up busy call forward:</p> <ul style="list-style-type: none"> • Off hook the phone; • Dial *90 and then enter the number to forward the call; • Press Call softkey or Dial key.
*91	<p>Cancel Busy Call Forward. To cancel the busy call forward:</p> <ul style="list-style-type: none"> • Off hook the phone; • Dial *91; • Press Call softkey or Dial key.
*92	<p>No Answer Call Forward. To set up delayed call forward:</p> <ul style="list-style-type: none"> • Off hook the phone; • Dial *92 and then enter the number to forward the call; • Press Call softkey or Dial key.
*93	<p>Cancel No Answer Call Forward. To cancel the delayed call forward:</p> <ul style="list-style-type: none"> • Off hook the phone; • Dial *93; • Press Call softkey or Dial key.



MULTI-FUNCTION BUTTON

PTT (Push to talk) button can be configured under **WP820 Web GUI → System Settings → Preferences → Button Customization → Multi-Function Button**, to perform the following functions:

PTT/Paging

When users select Multi-function button to be a PTT/Paging button, a short press on the button will take users to PTT/Paging settings. Users can also press and hold the key to initiate PTT/Paging call.

*Please, refer to the section **PTT (PUSH-TO-TALK) FUNCTIONALITY***

SAFE/Panic Call

Users could change the function of Multi-function button to SAFE/Panic Call, a short press on the key will open status page to make sure that Panic Call is enabled. Users can also press and hold the key to trigger Panic Call. *Please, refer to the section **SAFE/PANIC CALL***

Mute/Un-mute

If “Mute” is chosen to be the function of Multi-function button, users will be able to mute incoming calls ringtone by pressing on the key. Also, the key will be performing mute/unmute function during calls.

Speed dial

The multi-function key can be used to speed dial a contact. Note: The speed dial function will need to be setup before activating the feature.



PTT (PUSH-TO-TALK) FUNCTIONALITY

The WP820 supports the Push to talk (PTT) features which is a technology based on the instantaneous communication commonly employed in wireless cellular phone services using a button to switch the device from voice transmission mode to voice reception mode. This feature is similar to "walkie talkie" use and the PTT mode switches a phone from full duplex mode, where both parties can hear each other simultaneously, to half duplex mode, where only one party can speak at one time. Multiple parties to the conversation may also be included.

Enabling PTT mode on the WP820

You can enable and configure the PTT settings using the WP820 LCD menu:

1. Press **Menu** to bring up operation menu.
2. Use arrow keys to reach **Settings** → **Advanced settings** → **PTT and paging**.
3. Choose **PTT settings** and enable the **PTT function**.
4. Press **Save** button to enable PTT mode.

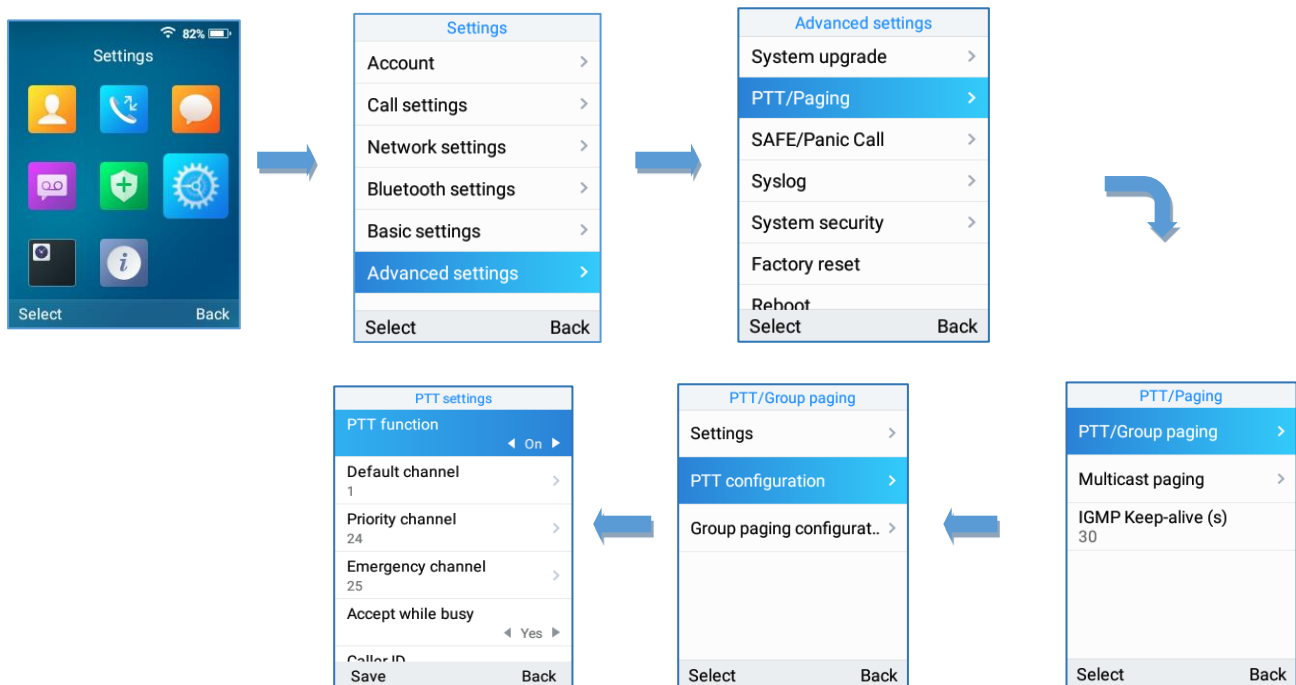

Figure 81: Enabling PTT Feature on WP820

Using the PTT Functionality on the WP820

To send a PTT broadcast from your WP820:

1. Unlock your WP820.
2. Make sure the multi-function button is configured to be a Push-To-Talk button.
3. Press the Push to Talk soft key.
4. Press and hold the Push to Talk key while speaking.

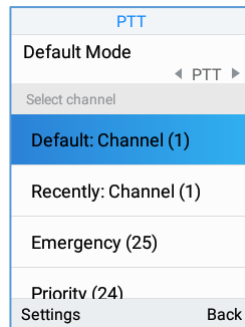

Figure 82: PPT Channel

Notes:

- Users could press and hold the Push-to-talk key from any screen to quickly initiate PTT call using default channel.
- The channel status will change to Sending PTT to indicate that you are transmitting as displayed on the following screenshot.

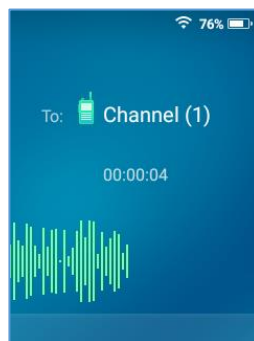

Figure 83: PTT Call (Caller)

- The devices which are in the same channel will receive the PTT call.





Figure 84: PTT Call (Callee)

- Release the Push to Talk soft key when you have finished speaking. The channel will wait 10 seconds before release.

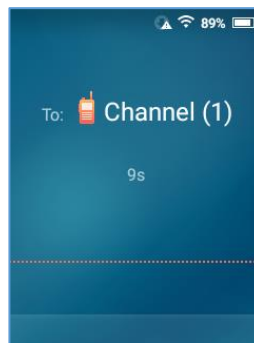

Figure 85: PTT Call Release

- You should press the Push to Talk soft key only when the channel status indicates Waiting. Otherwise, you may interrupt another person's message.

PTT Configuration Settings

Please refer to the following Settings for more details about the configuration of the PTT functionality:

Settings

- **Multicast address:** The multicast IP address to send page audio to and receive page audio from. Default value is 224.0.1.116.
- **Port:** The port to send audio to and receive audio from. Default value is 5001
- **Emergency volume:** The Volume of the emergency channel. Default value is 8

PTT Parameters

- **PTT function:** Enable or disable the PTT function.



- **Default channel:** The PTT channel used to transmit an outgoing page if the user does not explicitly specify a channel.
- **Priority channel:** The channel assigned for priority pages.
- **Emergency channel:** The channel assigned for emergency pages.
- **Accept while busy:** If no, incoming PTT sessions do not produce standard call waiting. If yes, incoming PTT sessions produce standard call waiting behavior on the active audio channel.
- **CallerID(*):** Caller ID number for identification.
- **PTTime:** The audio payload size in milliseconds.
- **Audio codec:** The audio codec to use for outgoing PTT broadcasts. Incoming PTT audio will be decoded according to the codec specified in the incoming message.
- **Channel:** Set the channel whether to be usable, transported, acceptable, joined and the channel display name.

Group Paging

Enabling Group Paging Feature

You can enable and specify settings for the Group Paging feature through the phone's user interface.

To specify the Group Paging feature settings:

1. Using your phone's interface, navigate to the Group Paging Configuration menu by pressing **Settings**→ **Advanced setting**→ **PTT and paging**→**PTT and group paging**.
2. Choose Group Paging Configuration.
3. Set Group Paging function to Enabled.

Please, refer to the following screenshots:



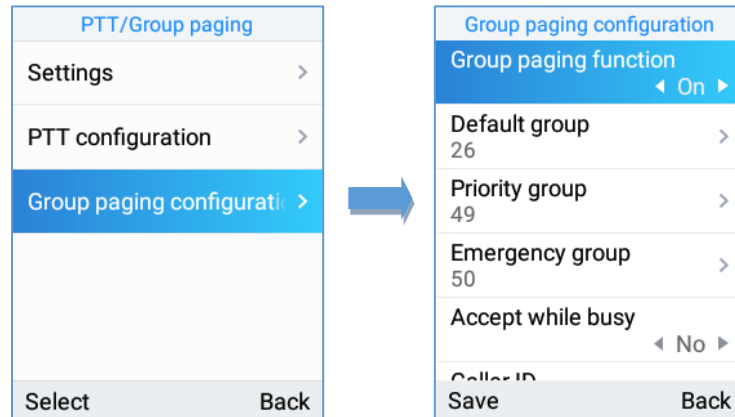

You can also enable and specify settings for the Group Paging feature through the Web GUI by selecting **Phone Settings → PTT/Multicast Setting**.

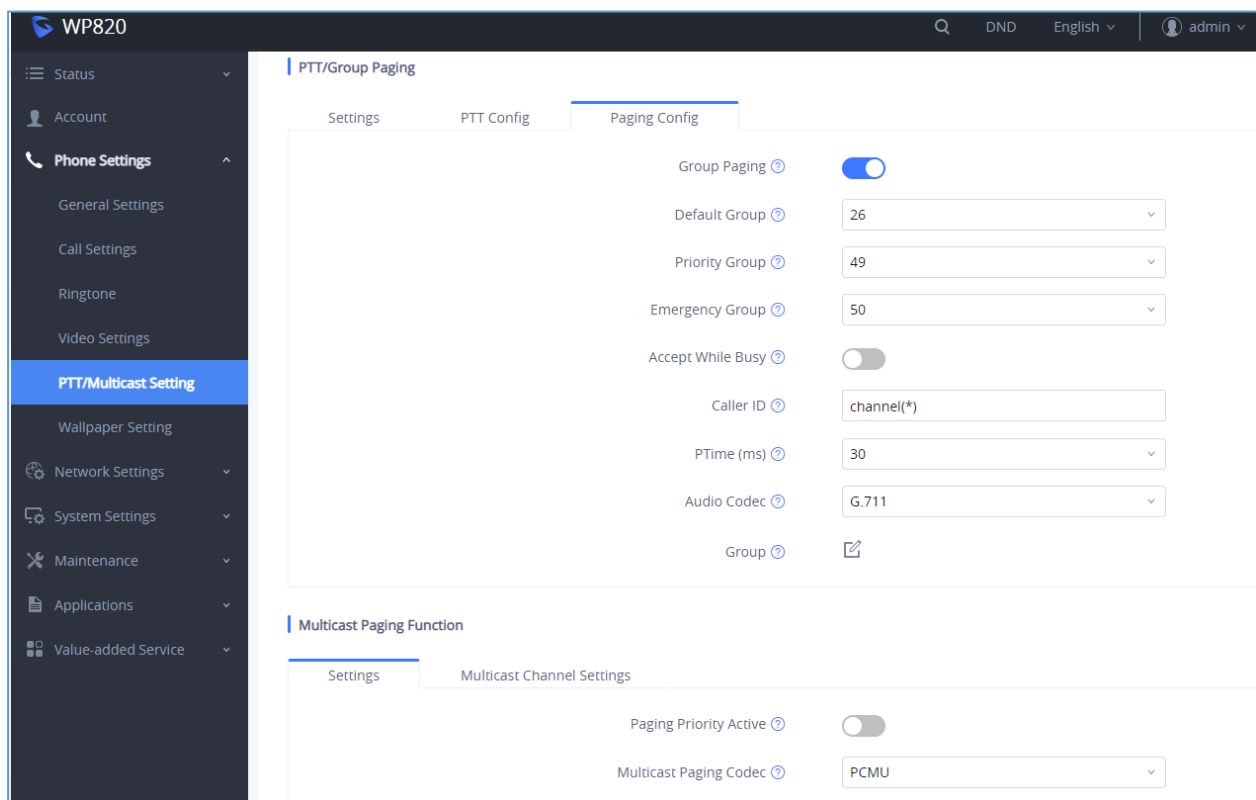

Figure 86: Enabling Group Paging

To send a Group Paging broadcast:

1. Unlock your WP820.
2. Press the Talk soft key.
3. Set Default mode to Group paging.



4. Scroll to the group you wish to send a broadcast to.

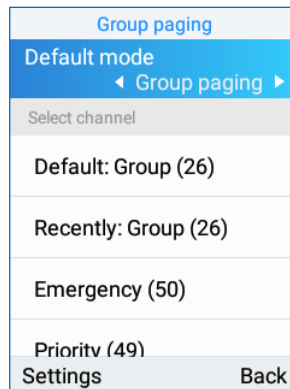

5. Press and hold the Talk soft key before speaking.

The group status will change to Sending group paging to indicate you are transmitting.

The devices which are in the group will receive the paging.

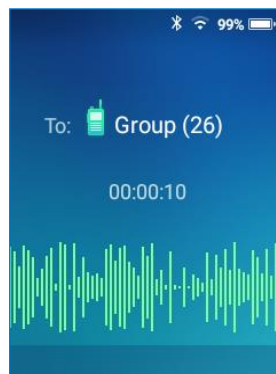

6. Release the Talk soft key, press the on-hook/power key when you have finished speaking.

Group Paging Parameters

- **Paging function:** Enable or disable the Group paging function.
- **Default group:** The group used to transmit an outgoing page if the user does not explicitly specify a group.
- **Priority group:** The group assigned for priority pages.
- **Emergency group:** The group assigned for emergency pages.
- **Accept while busy:** If no, incoming Group paging sessions do not produce standard call waiting. If yes, incoming PTT sessions produce standard call waiting behavior on the active audio group.



- **CallerID(*)**: Caller ID number for identification.
- **P-Time**: The audio payload size in milliseconds.
- **Audio codec**: The audio codec to use for outgoing Group paging broadcasts. Incoming Group paging audio will be decoded according to the codec specified in the incoming message.
- **group**: Set the group whether to be available、transmit、subscribe、join group and the group name.

IGMP Settings

Users could specify how often the phone will report IGMP when PTT/ Paging function is turned on. IGMP reporter help to keep PTT/ Paging receivable in dormant state. The interval may take some effect to standby time. The default setting is 30 s.

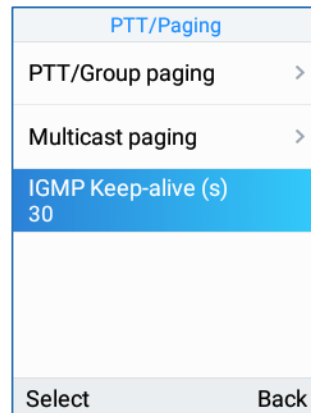

Figure 87: IGMP setting

SAFE/PANIC CALL

Safe Monitoring Features

SAFE monitoring feature on WP820 will monitor the user's safety situation and trigger an alarm once it detects any unsafe situation. Once the phone detects that the user may be in a dangerous situation such as unable to move, fall, or being chased using "Safe Monitoring Feature", the WP820 can quickly alert or initiate an emergency call for timely assistance.

In particular, the phone will automatically prompt a warning alert and message once it detects any unsafe situation. If the user does not cancel the prompt warning message to confirm its safety within the set time, an alarm will be triggered and an emergency call will be initiated (if configured) for assistance.

There are three major types of safety detection methods that can be set on SAFE monitoring settings:

- **No movement detection:** It detects when the user may be unable to move because of an injury or a coma, etc. Users can configure the duration of the no movement. If it stays no movement longer than the duration, the device will be triggered for detection.
- **Tilt detection:** It detects when the user may be in a state of slipping or falling, etc. Users can configure the sensitivity and timeout for this detection. With higher sensitivity level on tilt status, a relative slight falling action will trigger tilt detection and alert.
- **Running detection:** It detects when user may be in a status of being chased or escaping from a dangerous environment. Users can configure the sensitivity and timeout for this detection. With higher sensitivity level on running status, a slower running speed will trigger the running detection.

Users could configure the following SAFE monitoring options under **WP820 LCD → Menu → Settings → Advanced settings → SAFE/Panic Call → SAFE Monitoring Settings:**



Table 14: SAFE Monitoring Settings

Option	Description
Monitoring	Turn on/off the SAFE monitoring feature.
No Movement Sensitivity	Set the sensitivity of “No movement” detection. There are 7 levels available for detection. Choose Disabled to stop No movement detection.
No Movement Timeout (s)	Set the timeout value for “No movement” detection. The phone will start warning if the phone keeps no movement until timeout.
Tilt Sensitivity	Set the sensitivity of “Tilt detection”. There are 7 levels available for detection. Choose Disabled to stop Tilt detection.
Tilt Timeout (s)	Set the timeout value for “Tilt detection”. The phone will start warning if the phone keeps tilt until timeout.
Running Sensitivity	Set the sensitivity of “Running detection”. There are 7 levels available for detection. Choose Disabled to stop Running detection.
Running Timeout (s)	Set the timeout value for “Running detection”. The phone will start warning if the phone keeps waggle until timeout.
Snooze Timeout (s)	Set the timeout value of snooze. You can choose snooze while in warning/alarm State. After the timeout, the phone will start detect again.
Warning Timeout (s)	Set the timeout value of warning. The phone will start alarm if the phone keeps warning and not be canceled.

Panic Call Feature

Users can configure to have Panic Call feature on WP820 by setting it under **WP820 LCD → Menu → Settings → Advanced settings → SAFE/Panic Call**. This feature provides users the ability to manually/automatically trigger Alarm then initiate an emergency call to call for help in case of a dangerous situation.

- **Manual use:** Users can press and hold the multiple function key on the side of the phone to initial an emergency call (**Note:** Users need to configure the multi-function button to have the function of “SAFE/Panic Call” under WP820 Web UI). *Please, refer to WP820 Administration Guide.*
- **Automatic use:** If SAFE monitoring feature has been enabled, Emergency call can be initiated automatically once the phone detects the un-safe situation.

The following list is the list of options that can be configured for “Panic Call” feature under **WP820 LCD →**



Menu → Settings → Advanced settings → SAFE/Panic Call:

Table 15: Panic/Emergency Call Settings

Option	Description
SAFE Monitoring Settings	Configures “SAFE Monitoring Settings”.
Panic Call Silent Alarm	To trigger alarm in a silent way during urgent or dangerous situation, configure the Panic Call silent alarm option to be on. The default setting is off. This setting will enable the phone to initiate an emergency call silently. It is mainly used when it is not convenient to play an alarm in a dangerous environment.
Emergency Call	To initiate Emergency Call, users need to set the emergency call number after turning on this feature. The default setting is off.
Warning Tone	Set the Warning tone.
Alarm Tone	Set the Alarm tone.



WP820 GESTURE AND INTELLIGENT CONTROL

Intelligent Control

Intelligent Control options allow to automatically answer/hang up calls upon leaving charge/connecting to charger respectively.

To configure Intelligent Control options, follow instructions below:

1. On WP820 LCD Menu Settings, select **Basic Settings** → **Gestures** → **Intelligent Control**.
2. Set “**Off-Cradle Pickup**” to **On**, so that phone will automatically answer the call when leaving charge.
3. Set “**On-Cradle hang up**” to **On**, so that phone will automatically hang up the call when entering the charging state.

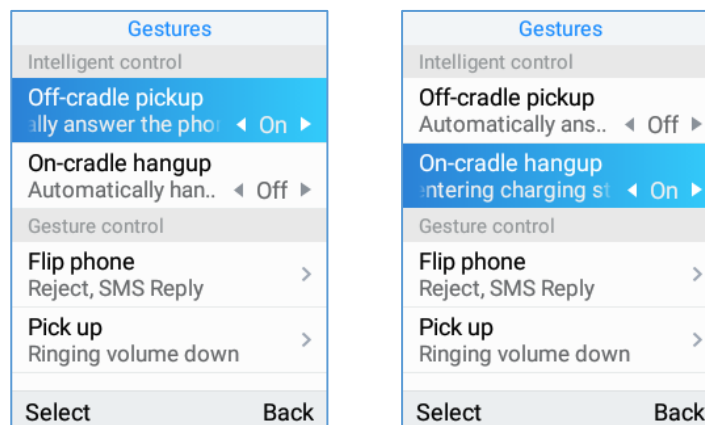

Figure 88: Intelligent Control Features

Gesture Control

Gesture Control options allow to perform actions (mute, decrease ringing volume, reject call...) based on the phone's gesture such as “Flip Phone” or “Pick up”.

Flip Phone

1. On WP820 LCD Menu Settings, select **Basic Settings** → **Gestures** → **Gesture Control**.
2. Tap on **Flip Phone** option and set the option needed when flipping the phone.
 - **Ringing on Incoming Call:**
 - **Off:** The feature is disabled even if the phone is flipped while receiving an incoming call.



- **Reject with SMS:** Incoming call will be rejected, and pre-defined SMS will be sent to caller when flipping the phone while receiving an incoming call. Note: SMS feature must be supported by SIP server, and users can customize SMS content by entering the message under “Reply Content”.
- **Reject:** Incoming calls will be rejected when flipping the phone while receiving an incoming call.

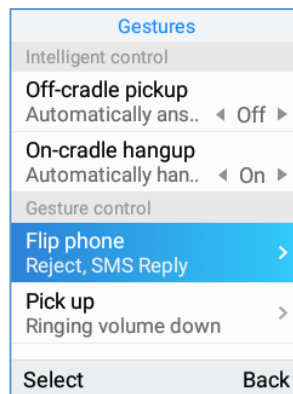

Figure 89: Flip Phone

Note: To flip WP820, when holding the phone up, put it down on his front side as shown in figure below.



Figure 90: WP820 Gesture Control (Flip phone)

Note: The incoming call will be rejected after 2 seconds when detecting the flip.

Pick Up

1. On WP820 LCD Menu Settings, select **Basic Settings** → **Gestures** → **Gesture Control**.
2. Tap on **Pick up** option. Two options are available:
 - **Ringtone:**
 - **Off:** The feature is disabled even if the phone is picked up when receiving a call.

- **Ringling Volume Down:** When set to this option, picking up the WP820 from its cradle while charging will result in reducing the ringing volume.
 - **Mute:** When set to this option, picking up the WP820 from its cradle while charging will result in muting the ringing.
- **Alarm Ringtone:**
 - **Off:** The feature is disabled even if the phone is picked up when Alarm ringtone is heard.
 - **Ringling Volume Down:** When set to this option, picking up the WP820 from its cradle while charging will result in reducing the ringing volume of Alarm ringtone.
 - **Mute:** When set to this option, picking up the WP820 from its cradle while charging will result in muting the Alarm ringtone.

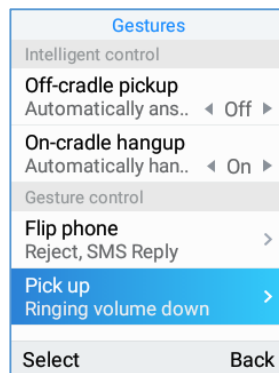

Figure 91: Pick up



Figure 92: WP820 Gesture Control (Pick up)

CONNECTING WP820 TO GDS3710 DOOR SYSTEM

The WP820 offers a powerful integration with GDS3710 Door System and allows users to open the door, initiates call to the GDS3710 and gets real time audio/video stream from the door system.

The WP820 can be connected with the GDS3710 in two different ways, either using peering mode (without a SIP server) or through a SIP server.

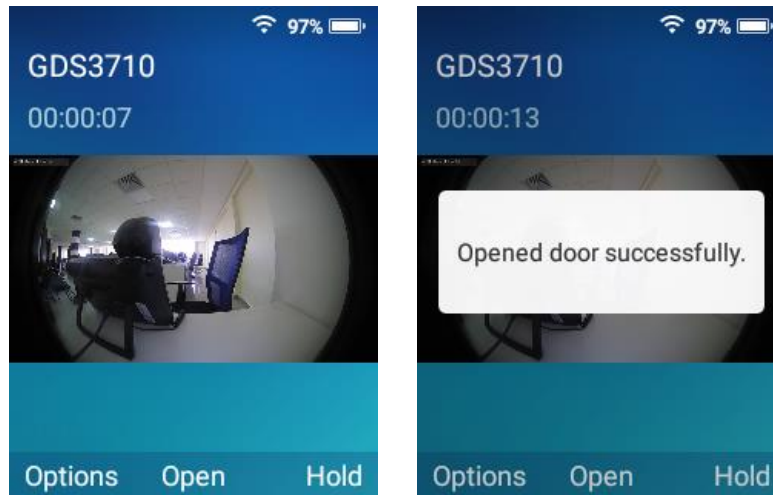

Figure 93: WP820 Connected to GDS3710

For more details, please, refer to:

http://www.grandstream.com/sites/default/files/Resources/Connecting_GDS3710_with_WP820.pdf

DIAGNOSTICS

The WP820's LCD, Audio and many other features can be diagnosed from the diagnostics APP. The sections below describe how the diagnosis is run:



Figure 94: Diagnostics APP

LCD Diagnostics

Proceed from Diagnostics APP → Click on LCD Diagnostics, and you can use the left/right Keys to change the pictures and OK to exit:

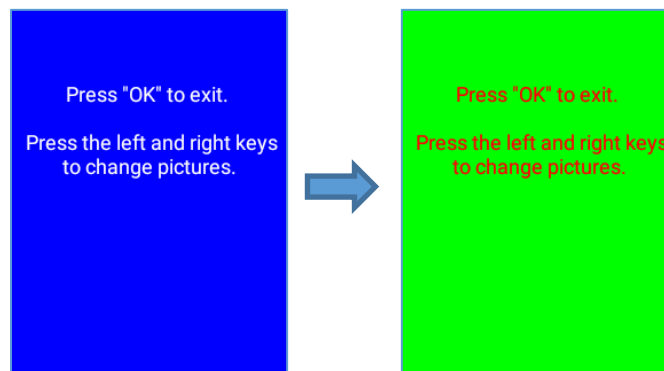

Figure 95: LCD Diagnostics

LCD Off

Proceed from Diagnostics APP → Click on Select to turn LCD Off, so that you can verify if the backlight does turn off.

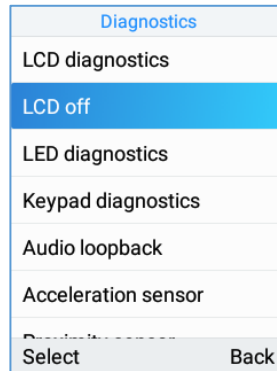

Figure 96: LCD Diagnostics

LED Diagnostics

Proceed from Diagnostics APP → Click on Select to run LED Diagnostics, and you can verify if the LED color changes upon key press during the test:

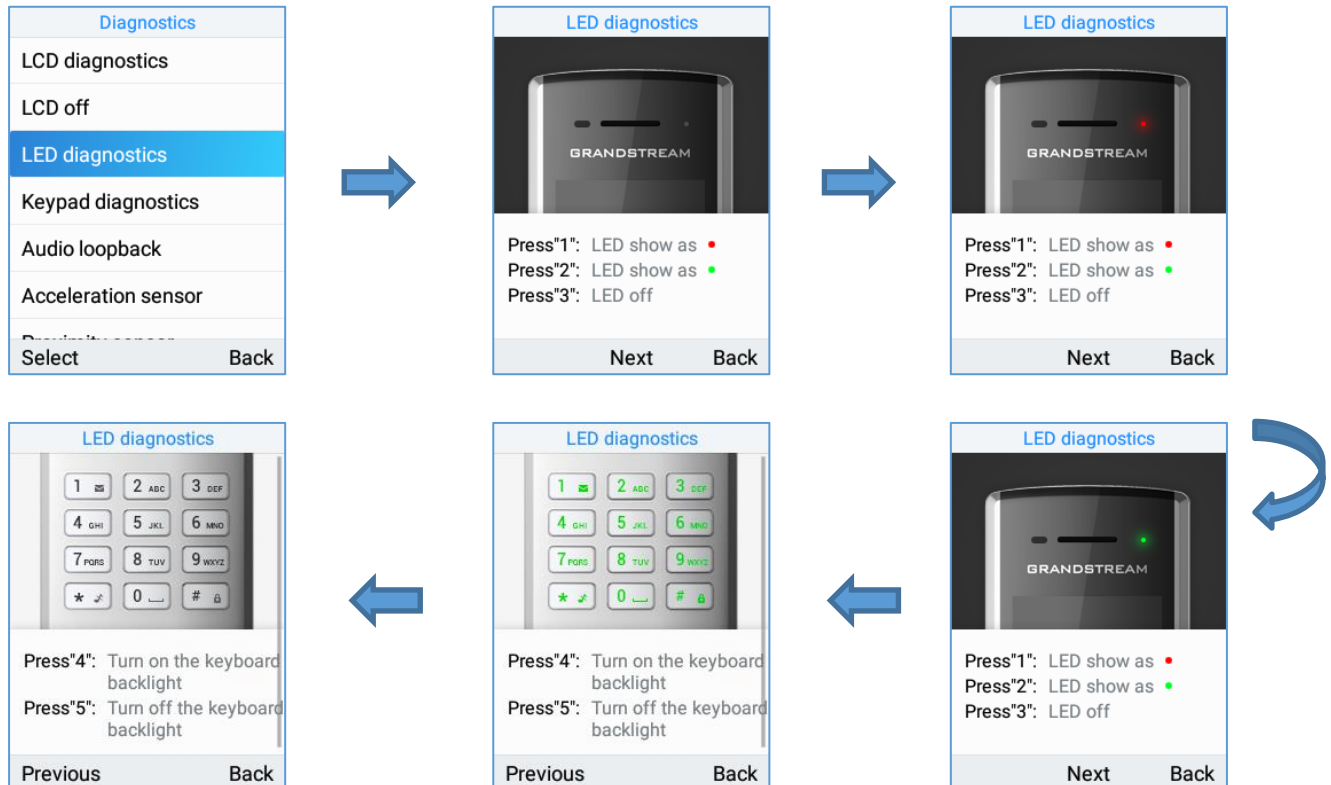

Figure 97: LED Diagnostics

Keypad Diagnostics

Proceed from Diagnostics APP → Click on Select to run Keypad Diagnostics, and you can verify if the keypad buttons are working fine:



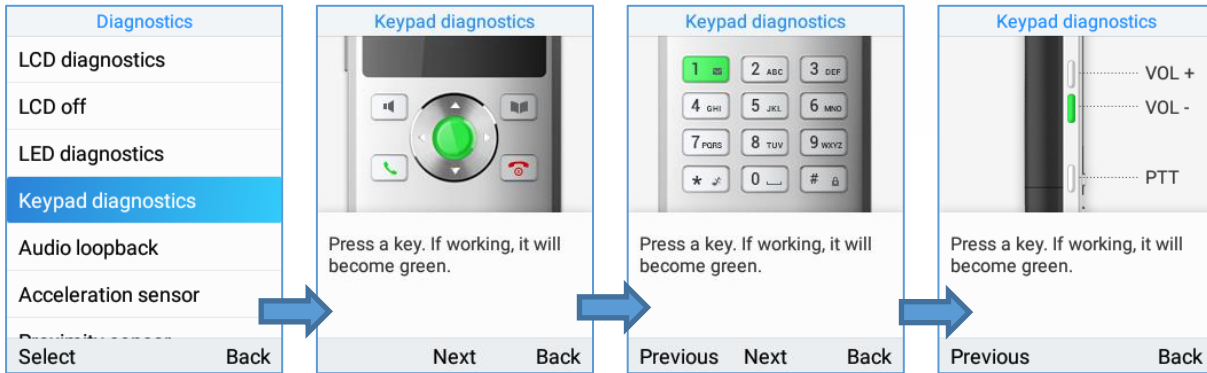

Figure 98: keypad Diagnostics

Audio Loopback

Proceed from Diagnostics APP → Click on Select to run Audio Loopback, so that you can verify if the microphone, earphone and back speaker are working fine.

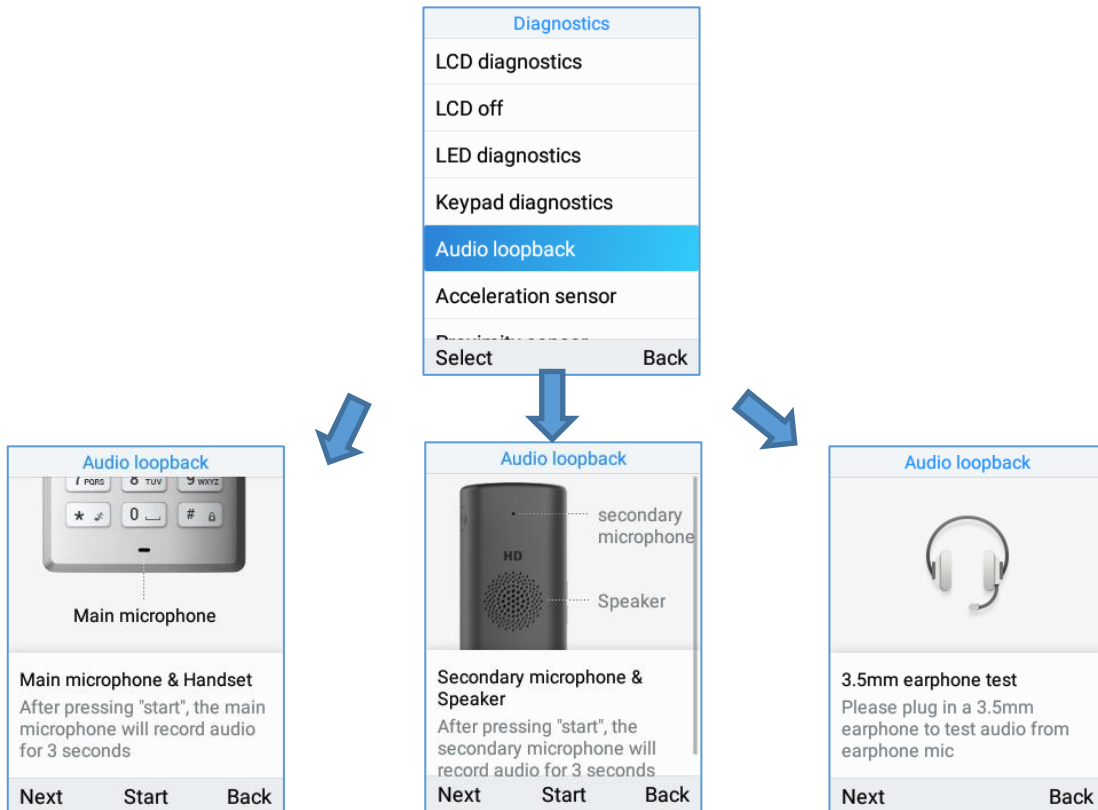

Figure 99: Audio Loopback

Acceleration sensor

Proceed from Diagnostics APP → Click on Select to run Acceleration sensor, so that you can verify if the acceleration sensor is operating fine by tilting the handset.

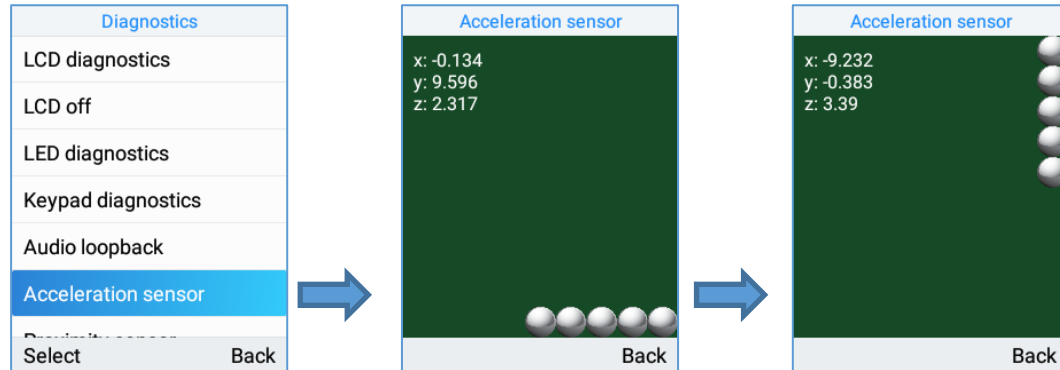

Figure 100: Acceleration sensor

Proximity sensor

Proceed from Diagnostics APP → Click on Select to run Proximity sensor, run the test by covering the sensor with a finger and wait for LED to go green.

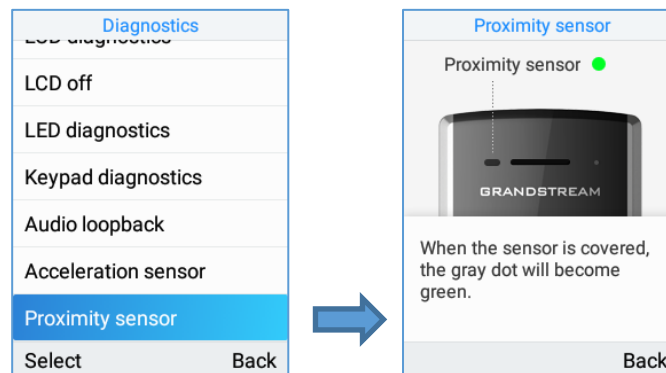

Figure 101: Proximity sensor

Vibration diagnostics

Proceed from Diagnostics APP → Click on Select to run Vibration diagnostics, run the test by selecting Vibrate.

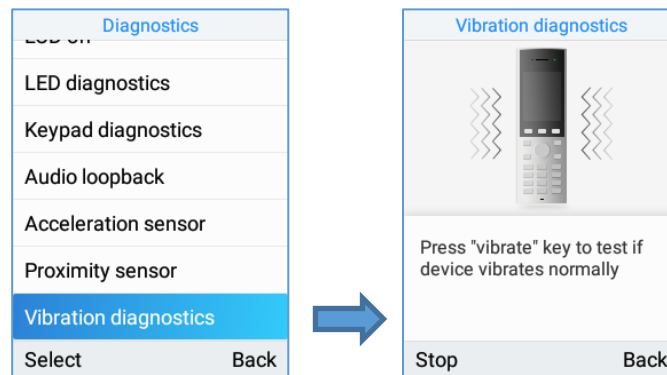

Figure 102: Vibration diagnostics

Certificate Verification

Proceed from Diagnostics APP → Click on Select to run Certificate Verification to verify the device's certificate.

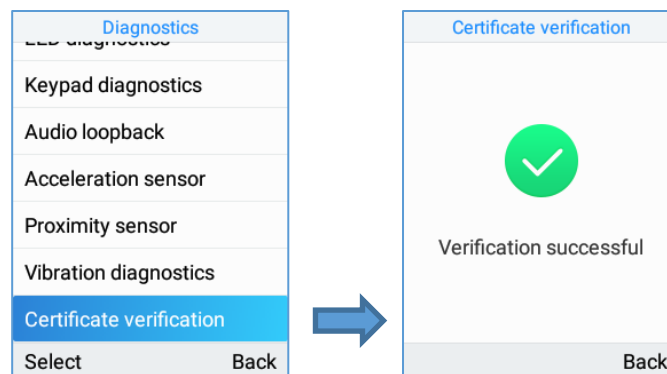

Figure 103: Certificate Verification

Traceroute

Proceed from Diagnostics APP → Click on Select to run Traceroute to a FQDN.

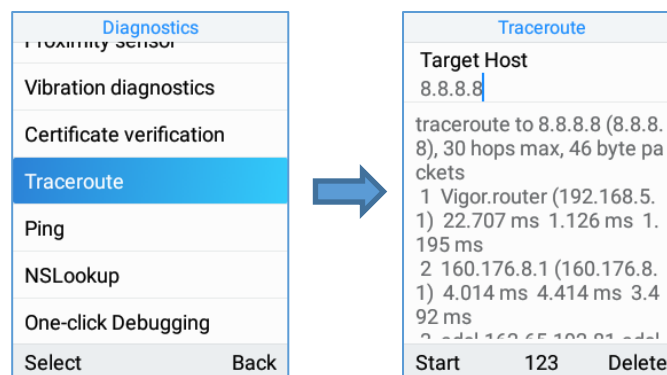

Figure 104: Traceroute

Ping

Proceed from Diagnostics APP → Click on Select to run ping to FQDN.

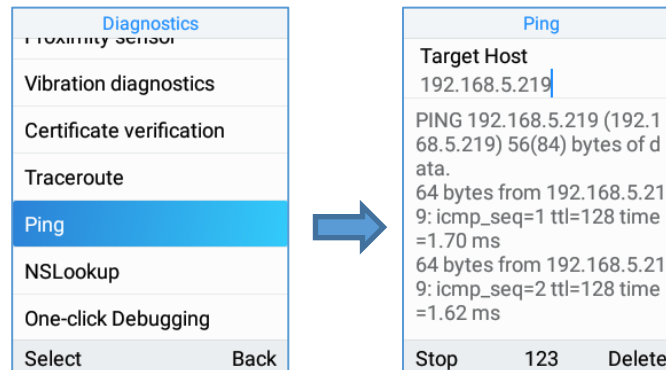

Figure 105: Ping

Nslookup

Proceed from Diagnostics APP → Click on Select to run nslookup on to a domain name.

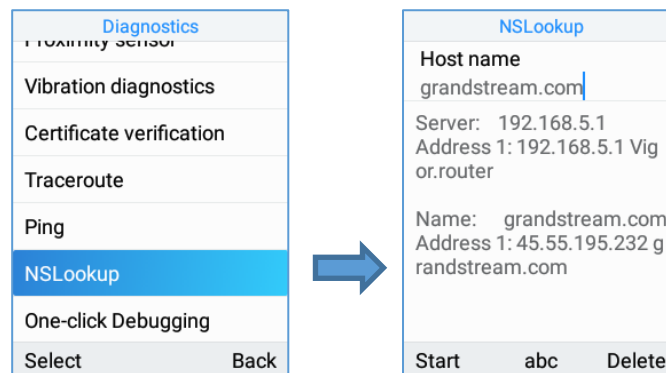

Figure 106: Nslookup

One-click Debugging

This feature allows user to launch the debug process from the LCD itself and to export the debug file via USB rather instead of accessing the web GUI to do so. Proceed from Diagnostics APP → Click on Select to run one-click debugging from the LCD.

1. Select the option One-click Debugging.

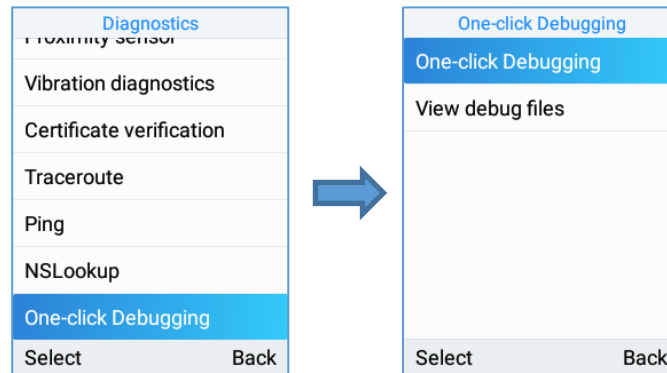

Figure 107: one-click debugging

2. Select the debug file menu options to be included in the debug Info file then click start

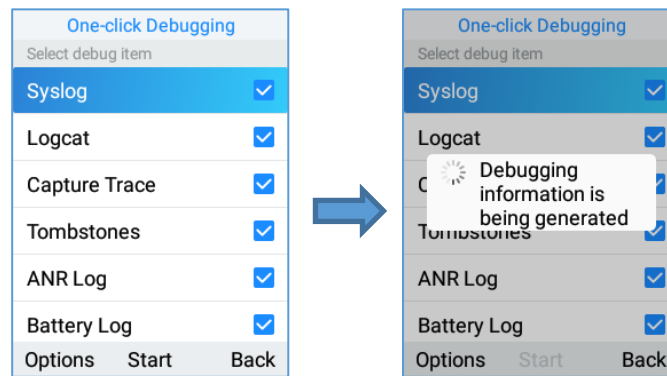

Figure 108: select debug mode and start capture

3. Click on stop then Back and select View debug file:

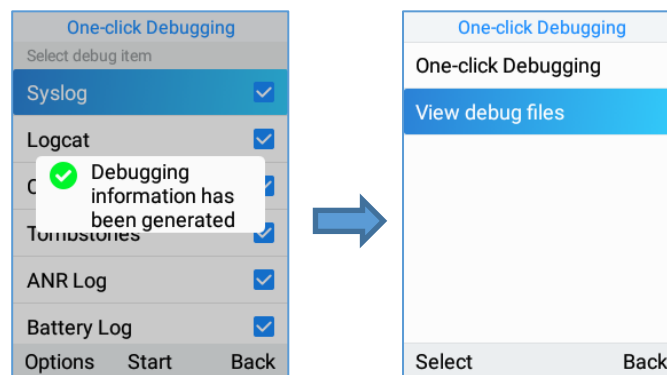

Figure 109: select debug mode and start capture

4. Export to USB drive or delete logs.

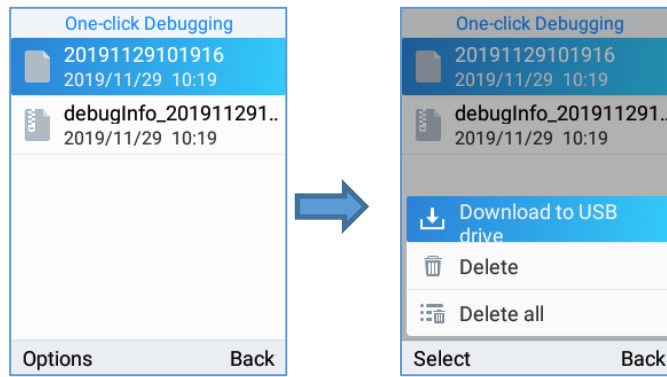

Figure 110: export or delete debug file

UPGRADING AND PROVISIONING

The WP820 can be upgraded via TFTP/HTTP/HTTPS by configuring the URL/IP Address for the TFTP/HTTP/HTTPS server and selecting a download method. Configure a valid URL for TFTP, HTTP or HTTPS; the server name can be FQDN or IP address.

Examples of valid URLs:

firmware.grandstream.com/BETA

fw.mycompany.com

Upgrade and Provisioning Configuration

There are two ways to setup upgrade and provisioning on WP820. They are Keypad Menu and Web GUI.

Configure via keypad Menu

1. In WP820 Settings, select **Advanced Settings** → **System Upgrade**.
2. Navigate to **Firmware/Config** and configure the firmware upgrade and config settings.

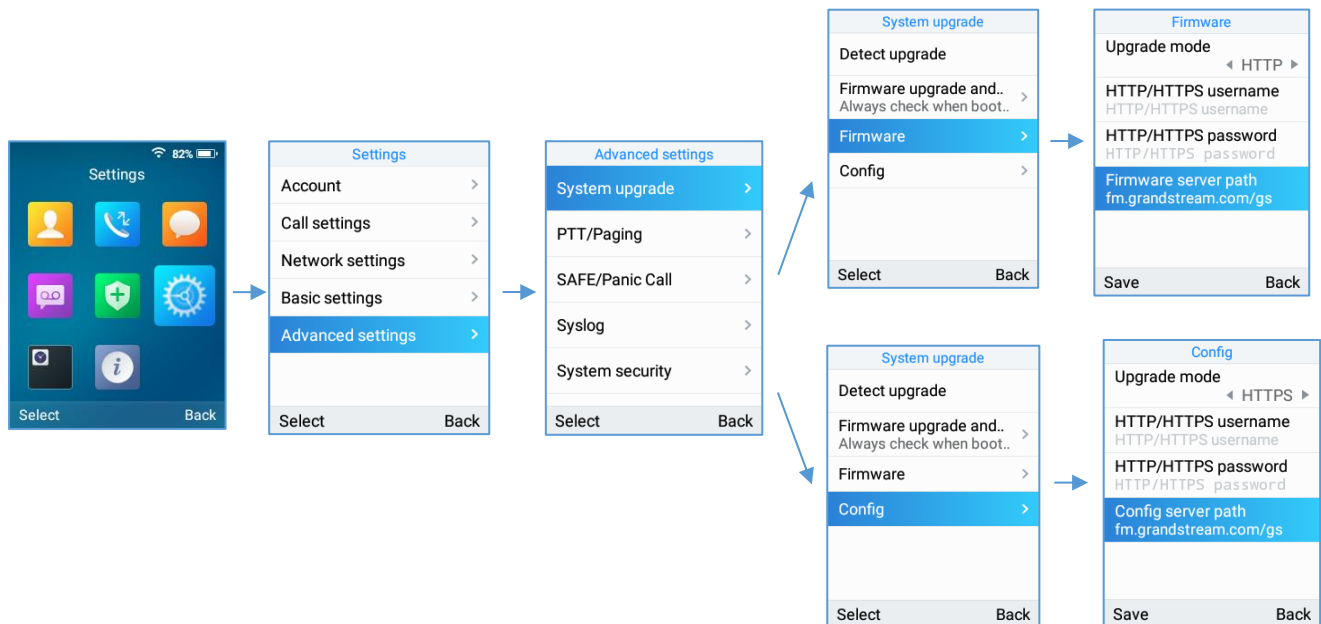

Figure 111: WP820 Upgrade Configuration via Keypad Menu

Configure via Web GUI

Open a web browser on PC and enter the IP address for the WP820. Then login with the administrator username and password. Go to **Maintenance** → **Upgrade** → **Firmware**. In the Upgrade web page, enter the IP address or the FQDN for the upgrade server and choose to upgrade via TFTP, HTTP or HTTPS (The default setting is HTTPS). Save and apply the changes, press **Upgrade** button or reboot the phone to initiate firmware upgrade process.

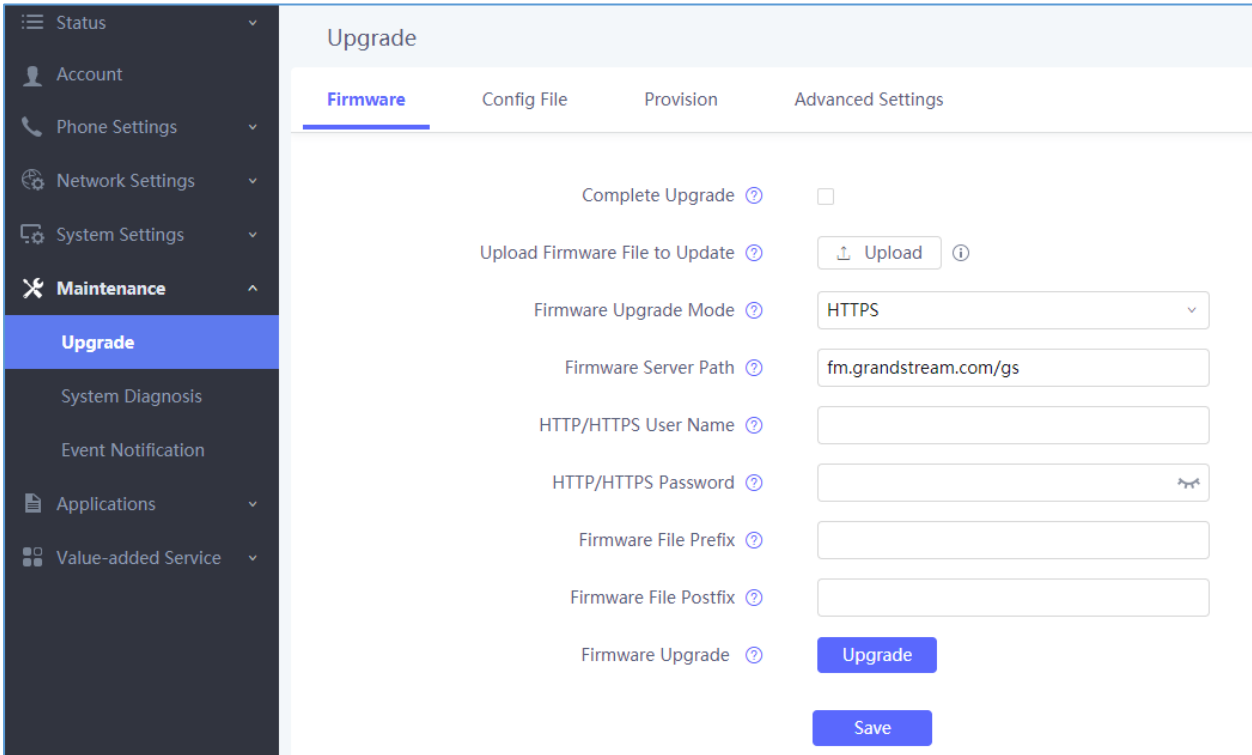

Figure 112: WP820 Upgrade Configuration via Web GUI



Note: Please do not power off or unplug the WP820 when the upgrading process is on.

Upload Firmware Locally

If there is no HTTP/TFTP server, users could also upload the firmware to the WP820 directly via Web GUI. Please follow the steps below to upload firmware to WP820 locally.

1. Download the latest WP820 firmware file from the following link and save it in your PC.
<http://www.grandstream.com/support/firmware>
2. Log in the Web GUI as administrator in the PC.
3. Go to Web GUI → **Maintenance** → **Upgrade** → **Firmware**.



4. Click the "Upload" button, a window will be prompted to select firmware file to upload.
5. Select the firmware file from your PC. Then uploading progress will show at the button where it was "Upload" in the above step.
6. When uploading is done, users can see the upgrading process starts on the WP820 LCD.
7. The phone will reboot again with the new firmware version upgraded.

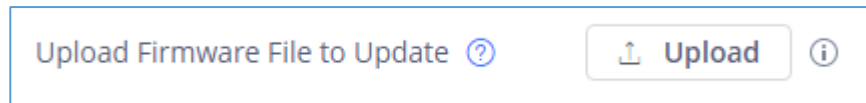

Figure 113: Upload Firmware File to Update

No Local Firmware Servers

Service providers should maintain their own firmware upgrade servers. For users who do not have a TFTP/HTTP/HTTPS server, some free Windows version TFTP servers are available for download from: <http://www.solarwinds.com/free-tools/free-tftp-server> and <http://www.tftpd64.com/>.

Please check our web site at <http://www.grandstream.com/support/firmware> for latest firmware.

Instructions for local firmware upgrade via TFTP:

1. Unzip the firmware files and put all of them in the root directory of the TFTP server;
2. Connect the PC running the TFTP server and the WP820 device to the same LAN segment;
3. Launch the TFTP server and go to the File menu→Configure→Security to change the TFTP server's default setting from "Receive Only" to "Transmit Only" for the firmware upgrade;
4. Start the TFTP server and configure the TFTP server in the phone's web configuration interface;
5. Configure the Firmware Server Path on your WP820 to the IP address of the PC;
6. Update the changes and reboot the WP820.

End users can also choose to download a free HTTP server from <http://httpd.apache.org/> or use Microsoft IIS web server.

Firmware Upgrade via USB

For users that could not use remote upgrade or could not access the phone's Web GUI to upload firmware, upgrading via external USB flash drive is an alternative. Follow the steps below to upgrade the WP820 via USB:

1. Download the firmware file to PC and save it in the USB flash drive
2. Insert the USB flash drive to the WP820.



- The following message will appear indicating that the USB drive is connected and the  icon will appear in the status bar.

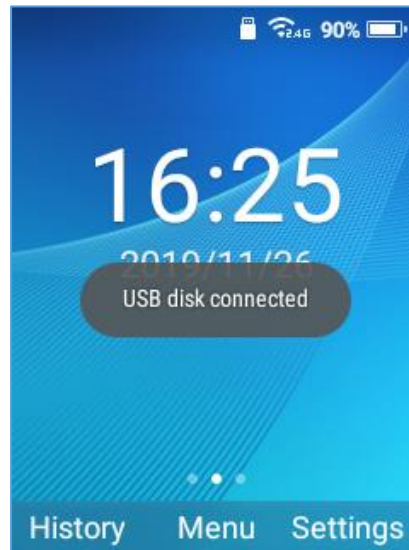

Figure 114: USB disk connected

- Power cycle the WP820 and wait for the device to detect the firmware.

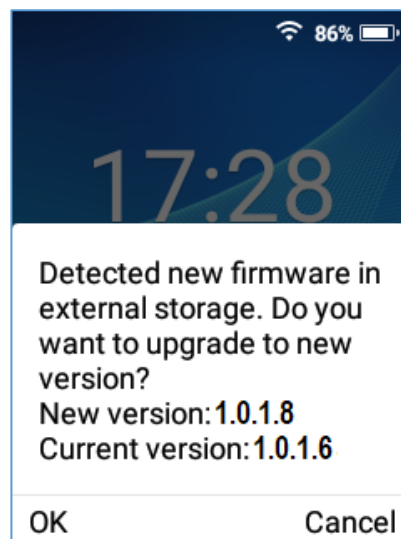

Figure 115: New Firmware Detected

- Press OK to start the upgrade.

Note: The USB flash drive should be on **FAT32** format and the firmware file should be necessarily named **wp820fw.bin**

Config Provision via USB

This feature allows the user to place a XML configuration file on a USB drive and upload to WP820.



Note: WP820 will automatically scan the USB drive for `cfg{mac}.xml` files after the connection is established. Please ensure only one instance of the file type is contained in the root directory of the USB drive.

1. Download the Config file to PC and save it in the USB flash drive
2. Insert the USB flash drive to the WP820.
3. Power cycle the WP820 and wait for the device to detect the Config file.

Wi-Fi Provision via USB

This feature allows the user to place a Wi-Fi configuration package on USB and upload to WP820.

Note: Please see the Wi-Fi configuration upload guide on the Grandstream product page for additional details by using the following URL:

http://www.grandstream.com/sites/default/files/Resources/WiFi_provision_guide.pdf

Provisioning and Configuration File Download

Grandstream SIP Devices can be configured via the Web Interface as well as via a Configuration File (binary or XML) through TFTP or HTTP/HTTPS. The "Config Server Path" is the TFTP, HTTP or HTTPS server path for the configuration file. It needs to be set to a valid URL, either in FQDN or IP address format. The "Config Server Path" can be the same or different from the "Firmware Server Path".

A configuration parameter is associated with each particular field in the web configuration page. A parameter consists of a Capital letter P and 1 to 5 (could be extended to more in the future) digit numeric numbers. i.e., P2 is associated with the "Admin Password" in the Web GUI → **System Settings** → **Security Settings** → **User Info Management** page. For a detailed parameter list, please refer to the corresponding firmware release configuration template in the following link:

<http://www.grandstream.com/support/tools>

When the WP820 boots up, it will issue TFTP or HTTP(S) request to download a configuration XML file named "cfgxxxxxxxxxxxx" followed by "cfgxxxxxxxxxxxx.xml", where "xxxxxxxxxxxx" is the MAC address of the phone, i.e., "cfg000b820102ab" and "cfg000b820102ab.xml". If downloading "cfgxxxxxxxxxxxx.xml" file is not successful, the provision program will download a generic `cfg.xml` file. The configuration file name should be in lower case letters.

For more details on XML provisioning, please refer to the following document:

http://www.grandstream.com/sites/default/files/Resources/gs_provisioning_guide.pdf



FACTORY RESET

Restore to Factory Default via LCD Menu

 **Warning:**

Restoring the Factory Default Settings will delete all configuration information on the phone. Please backup or print all the settings before you restore to the factory default settings. Grandstream is not responsible for restoring lost parameters and cannot connect your device to your VoIP service provider.

There are two methods to restore the WP820 to the factory default settings.

1. On WP820 idle screen, go to **Settings** → **Advanced Settings** → **Factory reset**.
2. In the new window, confirm the reset using the left softkey.

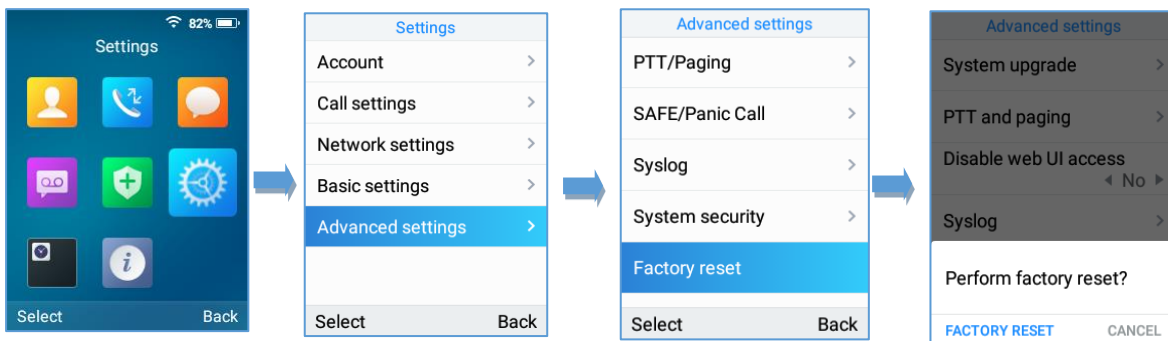

Figure 116: WP820 LCD - Confirm Factory Reset

3. Once confirming the factory reset, WP820 will reboot with the default factory settings.

Restore to Factory Default via the Web GUI

1. Login WP820 Web GUI and go to **Maintenance** → **Upgrade** → **Advanced Settings**;
2. At the bottom of the page, click on the **Reset** button for Factory reset.

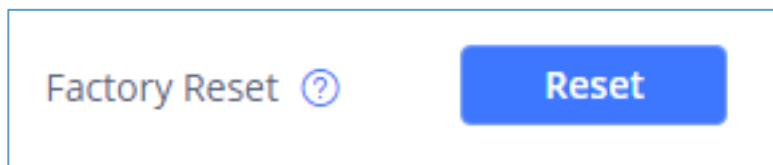

Figure 117: WP820 Web GUI - Factory Reset

3. A dialog box will pop up to confirm factory reset.

4. Click OK to restore the phone to factory settings.

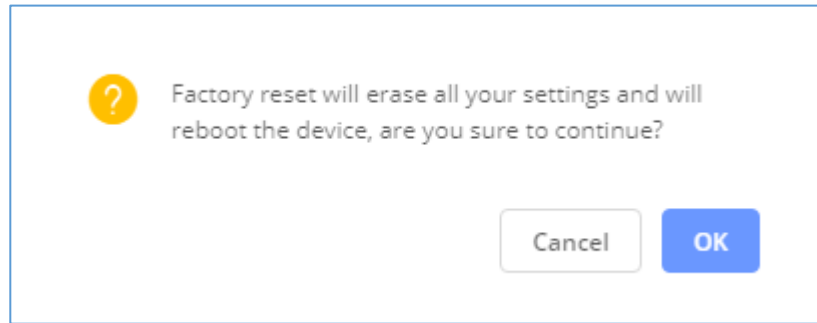

Figure 118: WP820 Web GUI - Confirm Factory Reset

Restore to Factory Default using Hard Keys

In order to perform hard reset of the phone using keypad buttons please follow below steps:

1. Power cycle the WP820.
2. Press key **1** + key **9** immediately and hold it until the LCD shows the factory reset message.
3. Release the buttons and the phone will boot up with the default settings.

Note: When constraint mode is enabled, user will need to enter their password before triggering factory reset process.

Quick Setup Wizard

The WP820 offers a Setup Wizard tool to help users to quickly configure basic settings on the device such as language, time zone, Wi-Fi and SIP account. The setup wizard appears automatically upon initial boot up of a factory default device.

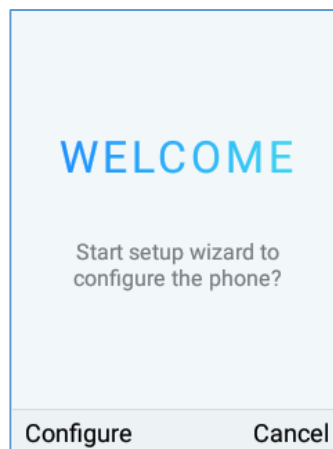

Figure 119: Setup wizard



EXPERIENCING WP820 ENTERPRISE PORTABLE WI-FI PHONE

Please visit our website: <http://www.grandstream.com> to receive the most up- to-date updates on firmware releases, additional features, FAQs, documentation and news on new products.

We encourage you to browse our [product related documentation](#), [FAQs](#) and [User and Developer Forum](#) for answers to your general questions. If you have purchased our products through a Grandstream Certified Partner or Reseller, please contact them directly for immediate support.

Our technical support staff is trained and ready to answer all of your questions. Contact a technical support member or [submit a trouble ticket online](#) to receive in-depth support.

Thank you again for purchasing Grandstream Enterprise Portable Wi-Fi Phone, it will be sure to bring convenience and color to both your business and personal life.

