

AQUATIC AV®

products with a watertight reputation

AQ-MP-5BT-H - WATERPROOF MEDIA PLAYER

for Bluetooth & MP3 devices

USER / INSTALLATION MANUAL



Replaces Factory Radio on Harley-Davidson® Motorcycles
(Models 1998-2013)



! PLEASE READ THIS INSTRUCTION MANUAL BEFORE
INSTALLATION AND OPERATION !

1 Getting Started	3
1.1 Contents.....	3
1.2 Connections.....	3
1.3 Wiring Diagram.....	4
1.4 Mounting Precautions.....	5
1.5 Installing the Media Player if no stereo is already installed.....	5
1.6 Installing the Media Player if an existing factory stereo is already installed.....	6
1.7 Connecting Rear Speakers.....	6
1.8 Handle Bar Controls.....	7
1.9 Power On.....	7
2 Location of Controls	8
2.1 Media Player Controls.....	8
3 Listening to Devices	9
3.1 Listening via Bluetooth.....	9
3.1.1 Pair with Bluetooth Device.....	9
3.1.2 Listening via Bluetooth Device.....	9
3.2 Listening via Auxiliary Input (3.5mm Jack).....	9
3.3 Adjusting Volume Level.....	9
3.4 Device Charging.....	9
4 Listening to FM/AM Radio	10
4.1 Enter FM/AM Radio Mode.....	10
4.2 Scan or Seek FM/AM Radio Channels.....	10
4.3 Saving Radio Channel to Memory.....	10
4.4 Listening to Saved Radio Memory.....	10
4.5 Switching between FM Tuning Areas.....	10
5 Settings Menu	11
5.1 Audio Menu.....	11
5.2 AS/PS (Auto Scan/Preset Scan).....	11
5.3 Clock Settings.....	11
5.4 Local/Distant Tuning.....	11
5.5 Stereo/Mono.....	11
5.6 FM Tuning Area.....	11
5.7 Beep Tone.....	12
5.8 System Reset.....	12
6 Specifications & Dimensions	13
6.1 Specifications.....	13
6.2 Dimensions.....	13
7 Warranty Information	14

1.1 Contents

- AQ-MP-5BT-H Digital Media Player
- Four-pin Speaker Wiring Harness
- Owner's Manual

1.2 Connections (see also '1.3 Wiring Diagram')

1. 23-pin Harley-Davidson® Standard Harness Connection

The 23-pin harness supplies power and ground connections to the Media Player, the two front channel high-level (speaker) outputs, as well as the handle bar control inputs.

2. FM/AM Radio Antenna Jack

Allows connection of FM/AM radio antenna. For best FM/AM performance make sure the antenna is extended to the highest achievable position.

3. Auxiliary Outputs

Allows external amplifiers to be connected to power additional speakers.

4. Auxiliary Inputs

Allows an additional RCA input, from a standalone unit or another stereo source.

5. 8-pin DIN Cable

Allows connection of the wired Remote Control (AQ-WR-5F sold separately) RF receiver.

6. Power Antenna / Amplifier Remote

Provides +12V signal to turn on an external amplifier.

7. Rear Channel High-Level (Speaker) Output

High-level rear channel speaker output (see section 1.7).

1.3 Wiring Diagram

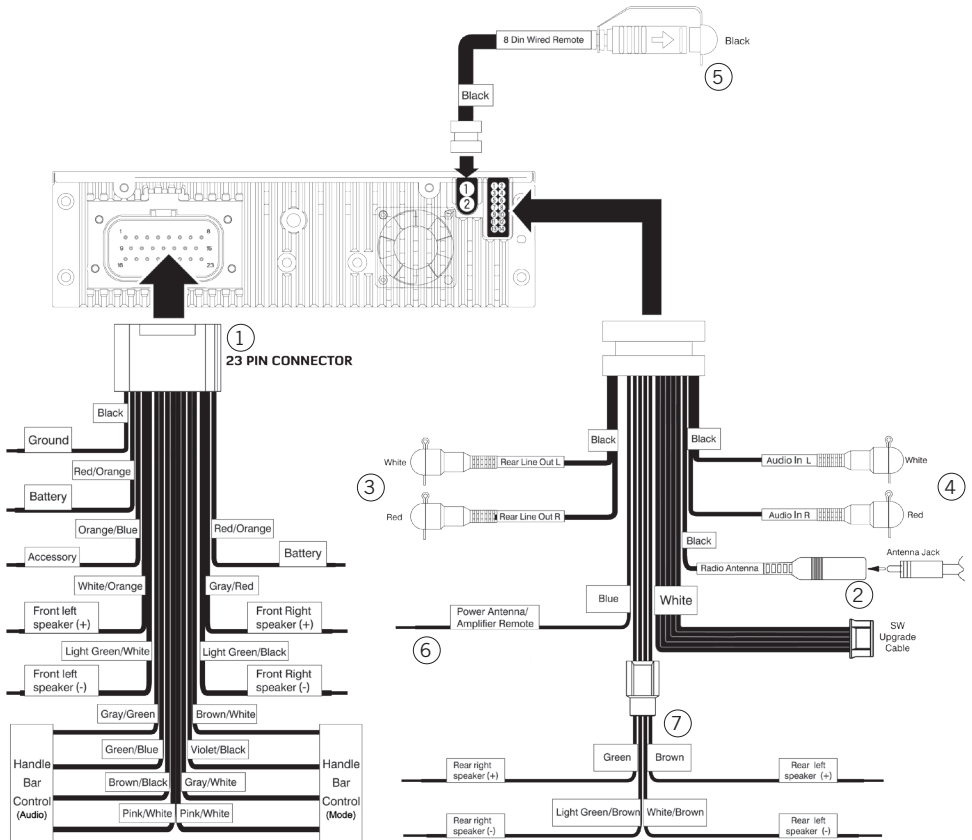

⚠ No lower than a 2 Ohm load should be used or damage may occur to the Media Player. Make sure the polarity of speakers are connected correctly.

1.4. Mounting Precautions

Please observe the following precautions:

1. Install the unit where it does not interfere with driving.
2. Check clearances on both sides of a planned installation before drilling any holes or installing any screws.
3. When routing RCA cables, keep them away from power cables and speaker wires.

i A common source of noise in the audio system is the motorcycle ignition system. This is usually due to the radio being located close to the ignition system (engine). This type of noise is detectable by a varying pitch with the speed of the engine.

Ignition noise can be removed using a high voltage radio suppression type ignition wire and a suppressor resistor. Your motorcycle may already use this wire and resistor but it may be necessary to check them to ensure they are operating correctly. Alternatively, a noise suppressor could be installed.

1.5 Installing the Media Player if no stereo is already installed

Use the existing Harley-Davidson® factory side mounting brackets and hardware to mount the Media Player.

1. Position the Media Player in front of the fairing opening so the wiring can be passed through the opening.
2. Follow the wiring diagram and ensure all connections are secure and insulated with crimp connectors to ensure proper operation.
3. Turn the Media Player on to confirm operation (motorcycle ignition switch must be on) and once correct operation is achieved turn the motorcycle ignition switch off before proceeding with the final mounting of the chassis.
4. Ensure that the unit is supported and secured on the sides using the existing 4 factory screws; failure to do so may allow the unit to move during while riding, causing damage to the mounting area.

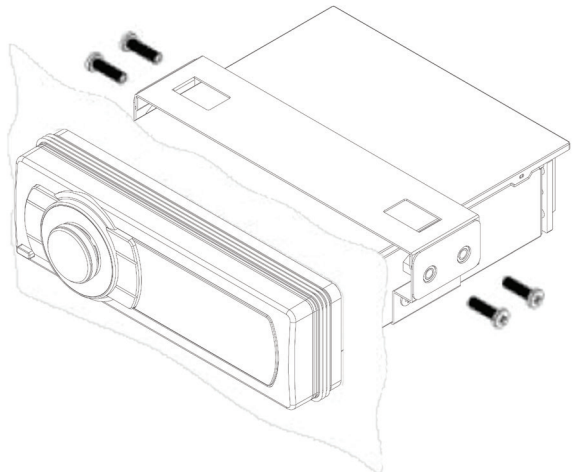

1.6 Installing the Media Player if an existing factory stereo is already installed

If replacing an existing Harley-Davidson® factory stereo use the existing Harley-Davidson® factory side mounting brackets and hardware to mount the Media Player.

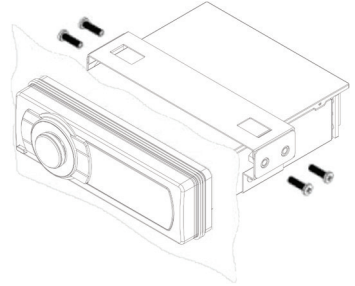

1. Disconnect the radio harness and FM/AM radio antenna from the factory stereo.
2. Remove the factory stereo and replace with the AQ-MP-5BT-H Media Player using the existing factory mounting hardware.
3. Plug the 23-pin radio harness plug and FM/AM radio antenna into the AQ-MP-5BT-H media player. Only the 23-pin harness plug is utilized by the media player. Any additional harness plugs will hang loose in your fairing.
4. Turn the Media Player on to confirm operation (motorcycle ignition switch must be on) and once correct operation is achieved turn the motorcycle ignition switch off before proceeding with the final mounting of the chassis.
5. Ensure that the unit is supported and secured on the sides using the existing 4 factory screws; failure to do so may allow the unit to move during while riding, causing damage to the mounting area.

1.7 Connecting Rear Speakers

Rear speakers are usually installed on the following Harley-Davidson® Motorcycle models: *Electra Glide Ultra Classic*, *Road Glide Ultra*, *Ultra Limited*. To continue using these speakers with your Aquatic AV Media Player follow the instructions below.

1. Locate the rear channel high-level (speaker) output (4-pin moxex connector with four speaker wires). The pigtail itself is labelled with Color Code, Function and Description.
2. Locate the rear channel speaker lines in the 35-pin radio harness plug. This plug will not be connected to your Aquatic AV head unit. Cut the 4 speaker wires for the rear channels at pins 1 and 24 (for the right side) and pins 2 and 25 (for the left side).
3. Strip the 4-pin pigtail wires 1/4" exposing bare wires. Strip the 4 wires that you cut from the 35-pin harness 1/4" exposing bare wires.
4. Connect and crimp using crimp caps or solder the connection, cover the soldered wires with non conductive heat shrink tube.

i After following the installation instructions above test your rear speakers for sound. If you do not have output from your rear speakers make sure to check your rear speaker setting in the settings menu and select rear speakers 'ON'.

1.8 Handle Bar Controls

Audio switch (left hand side)

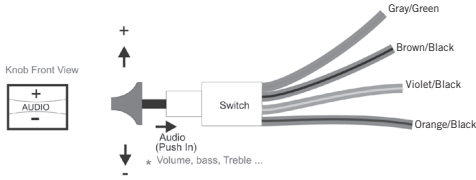

Mode switch (right hand side)

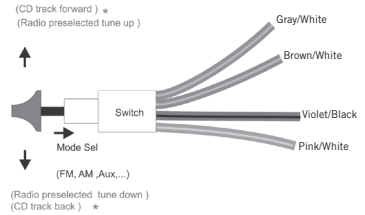

The AQ-MP-5BT-H is a plug and play solution for 1998-2013 Harley-Davidson® Motorcycles. Plug the standard Harley-Davidson® 23-pin connector in to the back of the AQ-MP-5BT-H and your speakers and hand controls will work the same as the standard factory install (some Harley-Davidson® models may require additional steps).

Some stock Harley-Davidson® features e.g. CB radio will not be supported through the AQ-MP-5BT-H.

Below is a matrix of what can be controlled on the AQ-MP-5BT-H via the stock Harley-Davidson® hand controls.

	Hand Control Up	Hand Control Down	Mode Select
AM/FM	Tunes to next station	Tunes to previous station	Switches Mode
Bluetooth	Next Track	Previous Track	Switches Mode
AUX			Switches Mode
	(+)	(-)	Audio
AM/FM	Turns volume up	Turns volume down	Accesses Audio menu adjustments
Bluetooth	Turns volume up	Turns volume down	Accesses Audio menu adjustments
AUX	Turns volume up	Turns volume down	Accesses Audio menu adjustments

1.9 Power On

The AQ-MP-5BT-H requires 12V DC to pins 10,20, and 12 in the 23-pin radio harness plug in order to power up. Ground should be connected to pin 11.

Once all connections are made press the rotary knob and the stereo will turn ON.

2.1 Media Player Controls

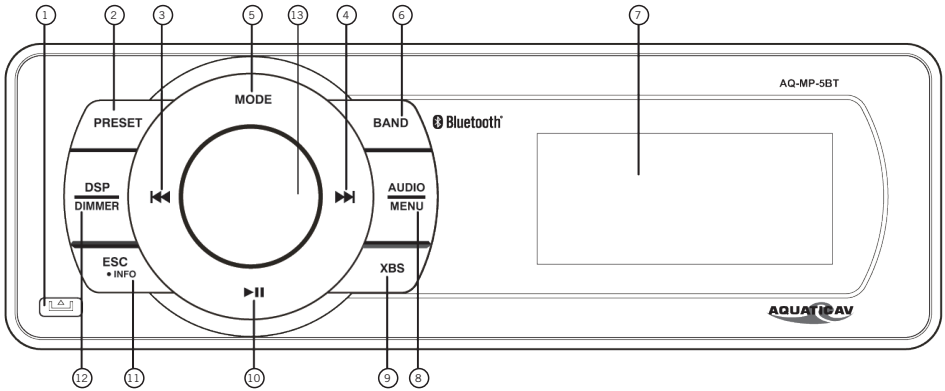

- | | | | |
|-----------------------|----------------|----------------------|------------------------|
| 1. Front face release | 5. Mode button | 8. Audio/System menu | 11. ESC/Info |
| 2. Preset station | 6. Band button | 9. XBS function | 12. DSP/Dimmer |
| 3. Previous/Rewind | 7. LCD screen | 10. Play/Pause | 13. Rotary Select Knob |
| 4. Next/Fast Forward | | | |

Button	FM Mode	Aux In	Bluetooth
Rotary Select Knob	Short Press: Mute		
	Long Press: Power Off		
Mode	In menu: Select		
	Short Press: Switches through different modes		
	Long Press: No Function		
Rotary Knob Clockwise	When turned clockwise the volume increases		
Rotary Knob Counter Clockwise	When turned counter clockwise the volume decreases		
Next	Short Press: Scans to the next station	No Function	Changes to next song
	Long Press: Switches into manual seek mode	No Function	No Function
Previous	Short Press: Scans to the previous station	No Function	Changes to Previous Song
	Long Press: Switches into manual seek mode	No Function	No Function
Play/Pause	Short Press: Toggles between Play and Pause		
	Long Press: No Function		
Band	Short Press: Switches between AM/FM Bands	No Function	No Function
	Long Press: No Function	No Function	No Function
XBS	Short Press: Toggles Bass Boost on/off		
	Long Press: No Function		
DSP/Dimmer	Short Press: Turns on EQ Preset		
	Long Press: Enables the two stage dimmer		
ESC/Info	Short Press: Return to the current mode screen, if you are in a menu. Display clock when on mode screen		
	Long Press: Displays info if any available	No Function	No Function
Preset	Short Press: Advances through presets	No Function	No Function
	Long Press: Set up new presets	No Function	No Function
Audio/Menu	Short Press: Takes you into the audio menu		
	Long Press: Takes you into the system menu		

i If your music player is connected via the Auxiliary input you will not be able to control track or receive track information.

i Turn off DSP to access control of Bass and Treble

3.1 Listening via Bluetooth

3.1.1 Pair with Bluetooth Device

1. Open the Bluetooth settings on your Bluetooth enabled device.
2. Select 'AQUATIC AV' from the list of available devices to pair (no password is needed).
3. A Bluetooth logo will illuminate on the Media Player LCD to verify Bluetooth is activated.

 *Only one Bluetooth device can be paired with the Media Player at any time.*

3.1.2 Listening via Bluetooth Device

1. After pairing a Bluetooth enabled device, switch the Media Player to Bluetooth Mode.
2. Media played on your paired device, will be transmitted to the Media Player.
3. The PLAY/PAUSE, NEXT, and PREVIOUS buttons will control their appropriate functions on your device.
4. A paired Bluetooth device can be controlled through the controls on the device, the faceplate controls, or using the handle bar controls.

3.2 Listening via Auxiliary Input (3.5mm Jack)

1. Remove the faceplate from the stereo.
2. Connect your MP3 device to the 3.5mm connector.
3. Re-attach the faceplate.
4. Press the rotary knob to power the Media Player ON (if the faceplate was removed with the stereo still powered on, it will power on by itself).
5. Press MODE on the Media Player or remote control to select 'AUX-1' mode.

 *Always ensure to connect and disconnect your Media Player with dry hands!*

3.3 Adjust Volume Level

1. Turn the rotary knob clockwise increase the volume.
2. Turn the rotary knob counter clockwise to reduce the volume.

3.4 Device Charging

1. Remove the faceplate from the stereo.
2. Place your device in the storage compartment and connect your USB device to the USB connector.
3. Re-attach the faceplate and ensure the stereo is switched on. The device battery will then charge.

 *The USB connector will provide charging only. Audio content stored on your device will not be recognized or playable by the stereo.*

4.1 Enter FM/AM Radio Mode

1. Press the MODE button to switch your Media Player to the radio mode.

4.2 Scan or Navigate FM/AM Radio Channels

1. Press the NEXT or PREVIOUS buttons to scan for the strongest radio signals in your area.
2. Press and hold the NEXT or PREVIOUS buttons to manually tune the radio to desired station.

4.3 Saving Radio Channel to Memory

1. Tune to the station you would like to be saved as a preset.
2. Press and hold the 'Preset' Button.
3. The stereo will enter the add preset button menu.
4. Using the rotary knob you can select which preset slot you would like to save the current station to.
5. Press the rotary knob to confirm your selection.
6. Upon successfully saving a preset the screen will display SAVED and the preset number selected will be shown in the right corner.

i Presets are only for the current band you are on. Each band FM1, FM2, FM3, AM1 and AM2 has six presets for a total of 30 (18x FM & 12x AM).

4.4 Listening to Saved Radio Memory

1. Once the presets have been set either manually or using AS/PS press the 'Preset' button to scroll through your presets.

4.5 Switching between FM Tuning Areas

1. When in 'RADIO' mode.
2. Press and hold the 'AUDIO/MENU' button to enter the System Menu.
3. Press the 'AUDIO/MENU' button to scroll through the options.
4. Scroll to 'AREA' then; turn the rotary knob to select your desired tuning area.
5. Once the desired tuning area has been selected you can press esc to return to FM Mode.

i US mode will increase and decrease the FM frequency in steps of 0.2 MHz, e.g. 88.1, 88.3, 88.5 MHz.
EUR mode will increase and decrease the FM frequency in steps of 0.05 MHz, e.g. 88.25, 88.30, 88.35 MHz.
RUSS mode will increase and decrease the FM frequency in steps of 0.05 MHz, e.g. 88.25, 88.30, 88.35 MHz.
LAT mode will increase and decrease the FM frequency in steps of 0.1 MHz, e.g. 88.2, 88.3, 88.4 MHz.
ASIA mode will increase and decrease the FM frequency in steps of 0.1 MHz, e.g. 88.2, 88.3, 88.4 MHz.
JAPAN mode will increase and decrease the FM frequency in steps of 0.1 MHz, e.g. 88.2, 88.3, 88.4 MHz.
MID E mode will increase and decrease the FM frequency in steps of 0.05 MHz, e.g. 88.25, 88.30, 88.35 MHz.
AUS mode will increase and decrease the FM frequency in steps of 0.1 MHz, e.g. 88.2, 88.3, 88.4 MHz.

5.1 Audio Menu

From the 'Audio Menu' you are able to change the bass, treble, balance, and fader.

1. To enter the 'Audio Menu' press the 'AUDIO/MENU' button.
2. In the 'Audio Menu' press the 'AUDIO/MENU' button to scroll through all options.
3. To change the parameters use the rotary knob to adjust settings.

i Any changes made in the 'Audio Menu' are system wide so it will affect all modes.

5.2 AS/PS (Auto Scan/Preset Scan)

Scans through the current frequency band, and assigns presets to the radio stations that have the strongest signal strength.

i Only does this for one AM/FM band at a time.

5.3. Clock Settings

The clock can be adjusted from the clock settings menu in the system settings. The clock can be accessed while on the mode screen by pressing the ESC button.

1. To change the clock, press and hold the AUDIO/MENU button to access the system settings.
2. Once in system settings, press the AUDIO/MENU button to scroll through settings until you reach Clock settings.
3. Turn the rotary knob left to adjust the hours and right to adjust the minutes.

5.4 Local/Distant Tuning

When 'Local' is turned on the Media Player seeks to only the radio channels with strong signal strength. When 'Local' is turned off the Media Player will seek to all radio channels it receives signal from.

i When local is turned on the word 'Local' will appear in the upper right hand corner of the Media Player LCD.

5.5 Stereo/Mono

Change the output mode between stereo and mono. Some applications only accept a mono input.

5.6 FM Tuning Area

The FM tuning can be set to different areas, using the rotary knob to scroll through to select the desired tuning area.

There are seven different tuning areas: USA, EUR, LAT, ASIA, MIDDLE EAST, AUSTRALIA, RUSSIA.

5.7 Beep Tone

Beep tone plays when any button is pressed, it can be toggled on and off from this selection.

5.8 System Reset

Restores all factory settings.

1. To restore your Media Player to factory settings, access the System Settings by pressing and holding the AUDIO/MENU button. Once in system settings press the AUDIO/MENU button again to navigate to the RESET option.
2. Press the rotary knob to confirm the reset. The Media Player will power off. After a few seconds manually turn the unit on by pressing the rotary knob once.

6.1 Specifications

Media

Supported media.....Bluetooth/MP3/FM/AM
Supported media max. dimensions.....107 x 184mm (WxH)
Device charging.....via USB

Inputs

Auxiliary.....1x 3.5mm stereo Jack socket, 1x stereo pair RCA

Outputs

Pre-Out.....1x stereo pair RCA (2V)

Power

Output voltage @ 2 Ohm.....4x 72W
Output voltage @ 4 Ohm.....4x 45W
Operation voltage.....9.6V - 14.4V DC
Max current draw.....7A
Standby current draw.....6mA

Multi-Environment Certifications

Waterproof / Dustproof.....Yes - IP55
Conformal PCB coating.....Yes
UV protection.....500 hours stable, ASTM D4329 compliant
Salt/Fog protection.....500 hours stable, ASTM B117 compliant
Stainless Steel mountings.....Yes

6.2 Dimensions

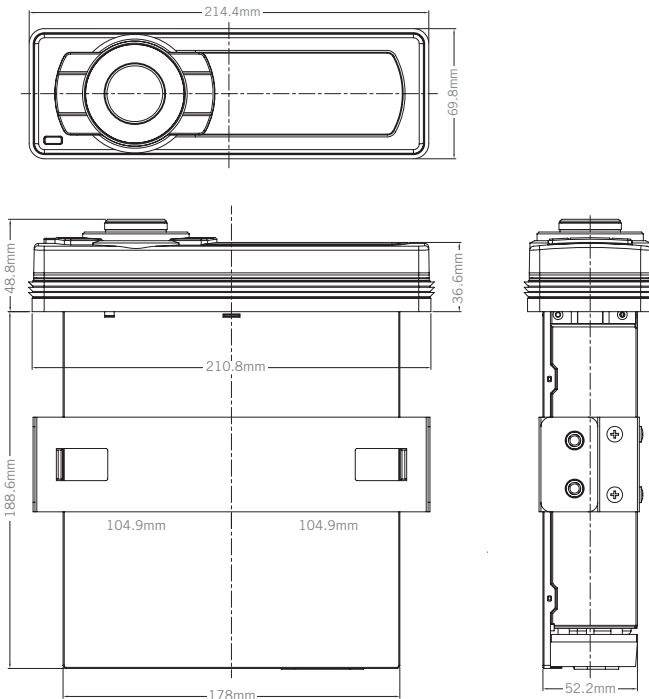

Aquatic AV offers a limited warranty of our products on the following terms:

Length of warranty

2 years on audio systems, electronics, speakers, and accessories (receipt required).

Coverage

This warranty covers only the original purchaser of an Aquatic AV product purchased from an authorized Aquatic AV dealer. In order to receive service, the purchaser must provide Aquatic AV with a copy of the receipt stating the customer name, dealer name, product purchased and date of purchase.

Defective products

Products found to be defective during the warranty period will be repaired or replaced (with a product deemed to be equivalent) at Aquatic AV's discretion.

What is not covered

Damage caused by accident, abuse, improper operations or theft. Any cost or expense related to the removal or reinstallation of product. Service performed by anyone other than an authorized Aquatic AV service center. Any product with the serial number or tamper labels defaced, altered, or removed. Subsequent damage to other components. Any product not purchased from an authorized Aquatic AV dealer.

Limit on implied warranties

Any implied warranties including warranties of fitness for use and merchantability are limited in duration to the period of the express warranty set forth above. Some states do not allow limitations on the length of an implied warranty, so this limitation may not apply. No person is authorized to assume for Aquatic AV any other liability in connection with the sale of the product.

How to obtain service

You must obtain a return material authorization number (RMA) to return any product to Aquatic AV. You are responsible for shipping charges of returned products to Aquatic AV.

Please record the model and serial number[s] of your equipment in the space provided below as your permanent record and will assist us with your factory warranty coverage. These numbers can be found on the rear of the unit.

Model number[s]:	Serial number[s]:

FCC ID:
MADE IN CHINA

This device complies with Part 15 of the FCC Rules. Operation is subject to the following two conditions: (1) this device may not cause harmful interference, and (2) this device must accept any interference received, including interference that may cause undesired operation.

NOTE:

The equipment has been tested and found to comply with the limits for a Class B digital device, pursuant to Part 15 of the FCC Rules. These limits are designed to provide reasonable protection against harmful interference in a residential installation. This equipment generates, uses and can radiate radio frequency energy and, if not installed and used in accordance with the instructions, may cause harmful interference to radio communications. However, there is no guarantee that interference will not occur in a particular installation.

If this equipment does cause harmful interference to radio or television reception, which can be determined by turning the equipment off and on, the user is encouraged to try to correct the interference by one or more of the following measures:

- Reorient or relocate the receiving antenna.
- Increase the separation between the equipment and receiver.
- Consult the dealer or an experienced radio/TV technician for help.

The manufacturer is not responsible for any radio or TV interference caused by unauthorized modifications to this equipment. Such modifications could void the user authority to operate the equipment.



**California Proposition
65 Warning**



WARNING: This product contains chemicals known to the State of California to cause cancer, and birth defects or other reproductive harm.

For more information: www.P65Warnings.ca.gov

Aquatic AV

282 Kinney Drive
San Jose, CA 95112, USA

E-mail: info@aquaticav.com

US & Canada: 1 877 579 2782

International: +1 408 559 1668

Fax: +1 408 559 0125

www.aquaticav.com

AQUATIC AV[®]
products with a watertight reputation